

THE NEW VALUE FRONTIER



Kyocera Group
CSR Report
2014

Contents

Management Rationale / Top Management Message

- 002 Corporate Motto / Management Rationale
- 004 Top Management Message

Management Philosophy

- 007 Kyocera Group Management Roots
- 009 Management Based on the Kyocera Philosophy
- 011 Advancing Kyocera Philosophy Education

Management

- 017 Kyocera Group Corporate Social Responsibility (CSR)
- 038 Corporate Governance

Respect for Human Rights / Optimal Work Environment

- 040 Respect for Human Rights and Diversity
- 048 Cultivation of Human Resources
- 053 Building a Safe & Secure Work Environment

Environmental Activities

- 060 Kyocera Group Environmental Management
- 067 Green Management: Basis of Environmental Management Promotion
- 075 Green Products: Environmentally Friendly Products
- 088 Green Factories: Environmental Consciousness at Plants and Offices
- 099 Green Communication: Transparency with Local Communities Regarding Environmental Matters

Fair Business Activities

- 103 Risk Management and Compliance
- 109 Supply Chain Management

Customer Concerns

- 113 Approaches to Raising Quality and Customer Satisfaction Levels

Social Contribution Activities

- 117 Supporting Academic Advancement and Research
- 120 Support for Culture and the Arts
- 122 International Exchange and Collaboration
- 125 Local Community Activities

-
- 133 ISO 9001 Certification Status
 - 134 ISO 14001 Certification Status
 - 136 OHSAS 18001 Certification Status
 - 137 Editorial Policy
 - 138 GRI and ISO 26000 Comparison Tables

Corporate Motto / Management Rationale

Corporate Motto

“Respect the Divine and Love People”

敬天愛人

Preserve the spirit to work fairly and honorably,
respecting people, our work, our company
and our global community.

Management Rationale

To provide opportunities for the material and intellectual growth of all our employees, and through our joint efforts, contribute to the advancement of society and humankind.

Management Philosophy

To coexist harmoniously with our society, our global community and nature. Harmonious coexistence is the underlying foundation of all our business activities as we work to create a world of prosperity and harmony.

Methods of Management

1. To earn fair profit through harmonious business practices that result in products that satisfy our customers — providing quality products at lower prices, realized through ongoing R&D and sincere service.
2. To manage our company as if we were a family, hearts bound together devoid of antagonism, helping each other with a mutual sense of gratitude and appreciation.

Coexistence

In order for the human race to survive and prosper in the future, we must remember the concept of coexistence. This is the concept that all living things on Earth must coexist together.

All living things on Earth, including human beings, depend on each other for survival.

In the future, management must be based on collaboration for mutual success. Fostering relationships where we all share a common vision and are willing to help one another and share in the burden so we can all grow together — this is the kind of management philosophy that future prosperity will require.

Based on the idea of coexistence, Kyocera will continue to strive towards corporate activities aimed at the prosperity and harmony of humankind.



Kazuo Inamori
Founder and
Chairman Emeritus
KYOCERA Corporation

Kazuo Inamori

Top Management Message

Contributing to the advancement and development of humankind and society through practice of the Kyocera Philosophy



Tetsuo Kuba
Chairman
KYOCERA Corporation



Tatsumi Maeda
Vice Chairman
KYOCERA Corporation



Goro Yamaguchi
President
KYOCERA Corporation

Correct Application of the Concept, “Do What is Right as a Human Being”

At the heart of Kyocera Group management is the corporate philosophy known as the Kyocera Philosophy, which emphasizes the importance of fair business based on ethical, moral and social standards that people should uphold throughout life. Ultimately, it comes down to one criterion for making decisions: “What is the right thing to do as a human being?”

To realize our corporate philosophy, Kyocera developed a unique management control method known as the Amoeba Management System. With this system in place, Kyocera promotes a management method in which all employees can participate. Furthermore, Kyocera believes in highly transparent corporate activity with timely disclosure of information to customers, employees, shareholders, investors, business associates, and all other stakeholders.

For the Kyocera Group, CSR is tantamount to the practice of the Kyocera Philosophy — the heart of Kyocera Group management. We believe practice of the Kyocera Philosophy builds mutual trust with stakeholders, and contributes to sustainable growth for the Kyocera Group, as well as the overall development of society. We will continue to engage in corporate management through practice of the Kyocera Philosophy.

Kyocera will contribute to the advancement and development of humankind and society through practice of the Kyocera Philosophy.

Contributions to Society through Business Activities

We currently face a variety of issues including economic globalization, the diversification of people's values, increased energy demand, climate change, and a growing world population. The Kyocera Group aims to further develop its business with a focus on the expanding automotive and medical markets in addition to the telecommunications and environment & energy markets.

In the telecommunications market, we aim to provide comfortable operability and ease of use with compact, high-performance components for smartphones and tablets and with communication equipment and information equipment based on our proprietary technology — endeavoring to create products that satisfy a wide range of users.

In the environment & energy market, our focus is on power efficiency improvement, energy conservation and effective use of resources by incorporating solar modules and battery storage units as well as energy management systems designed to control energy use more efficiently. Furthermore, we are attempting to introduce clean energy in various forms and in different ways across business activities ranging from the design, installation and maintenance of solar power generating systems to the power generation business, thereby contributing to the development of an earth-friendly society.

In the automotive market, component and device businesses in the Kyocera Group are strategically linked to facilitate the development of new products in order to meet the expectations of the market, thereby helping to realize an automobile-based society that stays in harmony with the environment, while providing safety and comfort for users.

In the medical market, in addition to our existing medical materials business, we will pursue synergies of existing technology and products towards the development of products in new fields such as healthcare so that we can develop innovative medical materials and surface treatment techniques that help improve patient quality of life and further enhance the medical field.

Handling of Global CSR Issues

In order for the Kyocera Group to succeed in global competition and maintain its high pace of growth, we consider it important to further reinforce the management foundations and develop business activities rooted in each region while always respecting the inherent diversity of local customs and cultures.

The Kyocera Group is an active member of the UN Global Compact, the basic rules on human rights, labor, the environment and prevention of corruption, and conducts positive activities towards the resolution of CSR issues.

Currently, with full awareness that conflict minerals can be used to fund armed groups conducting human rights abuses in the Democratic Republic of the Congo and neighboring countries in Africa, we are striving to solve the problem while working with customers and relevant industrial associations.

Furthermore, we are also taking active measures for environmental preservation to cope with environmental issues including climate change based on the Kyocera Environmental Charter, which is our basic philosophy for the environment, and our Environment Vision 2020, which will guide the company's actions up to the year 2020.

We will continue to meet the expectations of all stakeholders of the Kyocera Group, thus building relationships of mutual trust and contributing to the robust development of society.

Kyocera Group Management Roots



Company members around the time of foundation

The origin of Kyocera Group management is the Kyocera Philosophy, a philosophy for work and life based on the real-life experiences and empirical rules of Kazuo Inamori, founder and chairman emeritus of Kyocera Corporation. With “What is the right thing to do as a human being?” as its most essential criterion, the Kyocera Philosophy expounds the significance of commitment to fair management and operation in compliance with the most fundamental human ethics, moral values and social norms.

What is the Kyocera Philosophy?

The Management Rationale of the Kyocera Group is: “To provide opportunities for the material and intellectual growth of all our employees, and through our joint efforts, contribute to the advancement of society and humankind.” The “material and intellectual growth” that we aim for includes the pursuit of economic stability, and entails the pursuit of mental riches as a human being, in the shape of life with purpose and job satisfaction through self-fulfillment in the workplace.

Additionally, the steady refinement of our technology allows us to provide the world with wonderful products one after another, and thereby contribute to the advancement of science and technology. At the same time, by steadily raising profits as a company we aim to contribute to the improvement of common welfare, through increased tax payments and other means. The guidelines for action in pursuing the Management Rationale are set out in the Kyocera Philosophy. As a state of mind for leading wonderful lives, we are striving day by day to practice the Kyocera Philosophy.

Origin of the Kyocera Philosophy

In 1959, with the generous support of the people around them, company founder Kazuo Inamori and seven other colleagues established Kyoto Ceramic Co., Ltd. (now Kyocera Corporation). Starting with a meager amount of capital, the company had no imposing office building or elaborate machinery in the beginning. All it had were fellow colleagues who shared the joys and sorrows and formed a close bond as members of one big family. Inamori then decided to base the management of the company on this bond of human minds. This is because he believed that while human minds are extremely changeable, they are also most dependable once the minds are bonded by strong trust.

Later, Inamori encountered many difficulties in managing Kyocera, but he overcame them each time believing in the strong bond of human minds. The Kyocera Philosophy was thus born as he debated his life and work.

Basic Ideas of the Kyocera Philosophy

The Kyocera Group believes that decisions should always be made through reason and based on the idea of “What is the right thing to do as a human being?” as the basic criteria to achieve compliance with public morals.

The criterion of “What is the right thing to do as a human being?” is based on the fundamental ethical and moral values of the natural goodness of human beings: “Don’t be greedy,” “Don’t cheat people,” “Don’t lie,” and “Be honest” are teachings we all received from our parents as children and represent the most basic principles of humankind.

We believe that when making decisions and taking action in daily life, we should resort to the criterion of “What is universally right as a human being” and not the criterion of “What best suits our own convenience.”

Kyocera Philosophy Pocketbook

A copy of the Kyocera Philosophy Pocketbook is distributed to each employee at Kyocera. Employees use various opportunities to apply the principles in the Pocketbook, and to independently learn and practice the Kyocera Philosophy. In April 2011, we published the Kyocera Philosophy Pocketbook II, which summarizes additional important points of the Philosophy. The updated Pocketbook is being progressively translated into multiple languages to aid penetration of the Kyocera Philosophy in bases overseas.

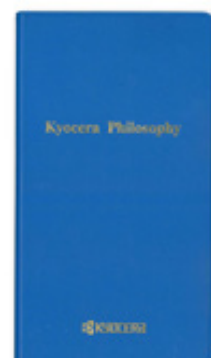

Management Based on the Kyocera Philosophy

For the Kyocera Group to realize the Management Rationale, correct understanding and application of the Kyocera Philosophy are essential. This applies also to Amoeba Management; Kyocera Management and Accounting Principles and The Twelve Management Principles. All are based on the Kyocera Philosophy.

Correct understanding and application are essential for future growth and development, to sustain the dreams of employees, and for the Kyocera Group to continue as a corporate group that contributes to the development of society. In addition, we also strive to promote understanding and diffusion of the Kyocera Philosophy among employees by distributing booklets and pocketbooks.

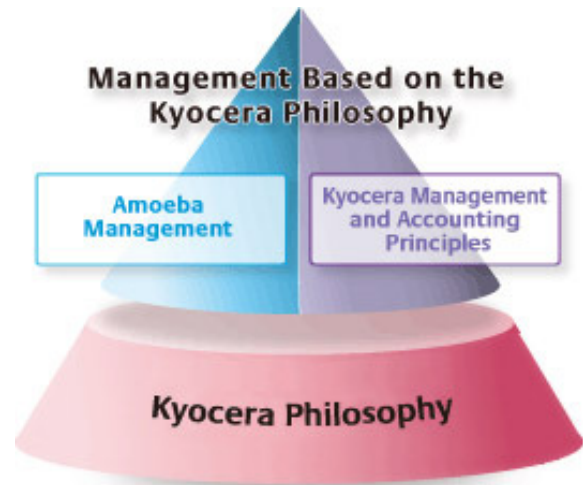

Amoeba Management

The Kyocera Group uses its own business administration method called the Amoeba Management System, which is specifically developed to realize the corporate philosophy of the Kyocera Group. Under this system, the company organization is divided into small groups called amoebas, which operate on a self-supporting basis. We believe that employees' enhanced sense of participation in management and motivation engendered by Amoeba Management constitutes the source of the Kyocera Group's strength. The small group system also serves to clarify the responsibilities of each member of the group, secure transparency in every detail, and enable a thorough check of efficiency.

The Objectives of Amoeba Management

1. Establish a market-oriented divisional accounting system
2. Foster personnel with a sense of management
3. Realize management by all

Kyocera Management and Accounting Principles

Accounting is integral to the management of a company as it plays the key role as the compass that leads a company to its destination. When handling accounting matters, it is important to trace them back to their essence and take appropriate measures according to our primary criterion of “What is the right thing to do as a human being?” Kyocera considers the ideal state of accounting to be one in which the facts are shown as they are, and recognizes the importance of fair and transparent management.

Kyocera Management and Accounting Principles are a set of practical accounting principles designed to give a correct understanding of the realities of the company and the directions to be taken. In the Kyocera Group, each employee is encouraged to understand and become familiar with the Kyocera Management and Accounting Principles, and to act in accordance with these principles. We believe this becomes a sound foundation not only for fair accounting, but also for the long-term development of the company.

Seven Basic Principles

1. The Principle of Cash-Basis Management
2. The Principle of One-to-One Correspondence
3. The Principle of Muscular Management
4. The Principle of Perfectionism
5. The Principle of Double-Checking
6. The Principle of Profitability Improvement
7. The Principle of Transparent Management

Advancing Kyocera Philosophy Education

Kyocera Philosophy Education: Basic Concept and Structure

In the Kyocera Group, a variety of Philosophy education programs are provided to each employee to familiarize them with the Kyocera Philosophy, realize the global growth of the Group through diligent efforts, and with originality and ingenuity, help all employees feel happy working for the Group in order to foster human resources capable of supporting the growth and development of society and humankind.



Group-Wide Philosophy Committee

In order to further enhance Philosophy education in the Kyocera Group, a Group-Wide Philosophy Committee was established with the Chairman as its head in May 2013. The Committee is engaged in the formulation of Philosophy education policy and the examination and determination of measures to promote further understanding and implementation.

Expanding Kyocera Philosophy Education

The Kyocera Group is expanding Kyocera Philosophy Education on a global basis in accordance with the policy of the Group-Wide Philosophy Committee.

In Japan, education is divided into programs provided individually by each department, site or Group company, based on the conditions of their specific business activities and the common programs that support the individual programs. In individual educational activities, actions to diffuse the front-line-conscious Philosophy are taken proactively by each department, site or Group company. The common programs include Leader Education, which teaches the Twelve Kyocera Management Principles, the basis of management, and the type of leadership required of managers; and the Philosophy Workshop, which teaches the basics of the Kyocera Philosophy. In addition to those Philosophy education programs, various education and diffusion activities are carried out including voluntary workshops, company journals, company Web sites, and a collection of Kyocera Group Philosophy Essays. Educational activities are also carried out overseas to match local customs and business types.

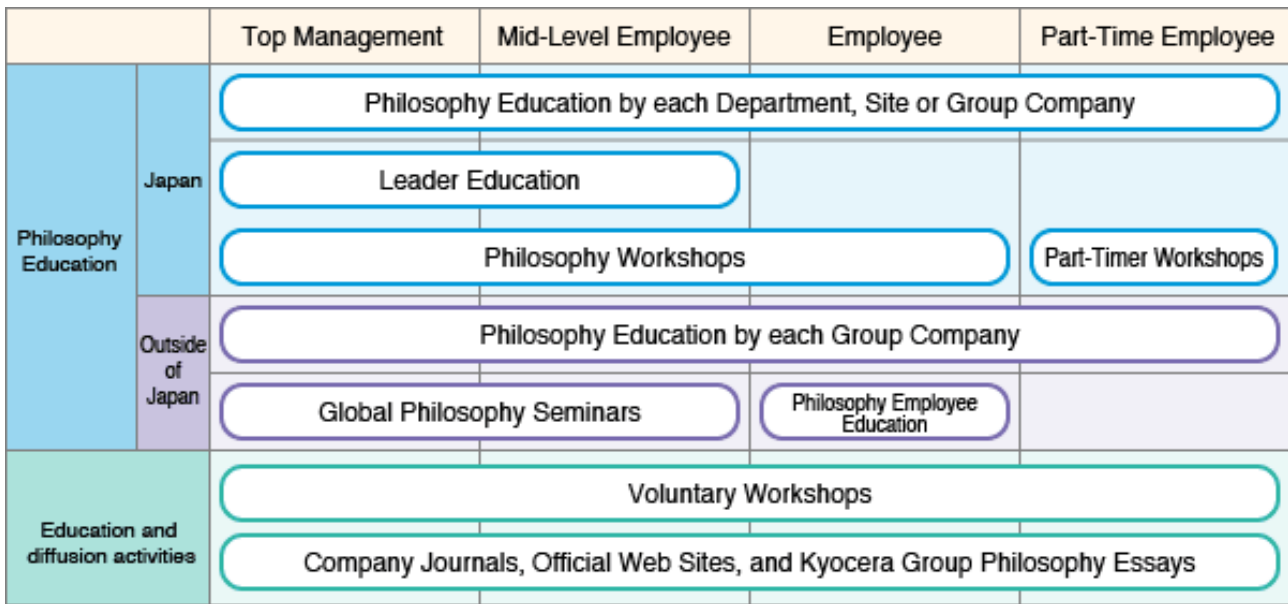

Diagram of the Kyocera Philosophy Education System

The Kyocera Group has implemented an educational system aimed at improving the understanding and practice of the Kyocera Philosophy as well as enhancing employee abilities through the acquisition of both specialized knowledge and skills necessary to execute their work. Specific educational programs provided to employees include Kyocera Philosophy Education, management education, function-based education, and technical and skills education. (see page 50)

Philosophy Education by Each Department, Site or Group Company

■ General Affairs Departments

The general affairs departments of Kyocera have set up the General Affairs Supervising HQ Philosophy Committee as a special organization to promote the activities of the Group-Wide Philosophy Committee inside the departments. Under the General Affairs Committee, a working group (WG) is established with members, mostly young personnel, selected from each department.

The WG reviews specific activities and their action programs aimed at optimizing general affairs departments and cultivating a sense of unity among general affairs members. The working group issues an in-house newsletter, Philosophy Times, and strives for the diffusion of the Kyocera Philosophy by encouraging employees to select concepts from the Kyocera Philosophy as their own targets, proclaim them in their own “My Philosophy Card” and present them at morning meetings.



Philosophy Times

■ Automotive Components Departments

The automotive components departments of Kyocera conduct two types of programs, one aimed at the growth and development of leaders with department heads as the main players, and the other the improvement of members' motivation. Specific activities include lectures given by leaders who talk about their own experiences with the Kyocera Philosophy and small group discussions. In addition, various activities are carried out to invigorate communication at job sites including the provision of opportunities to talk about the Kyocera Philosophy by means of morning meetings or casual parties where employees can share their problems and worries, thereby helping departments achieve their common objectives.



Philosophy education unique to automobile components departments

Holding of Leader Education

The Kyocera Group (Japan) started Leader Education in October 2013 for leaders at section manager level or higher aimed at having them learn anew the significance of the Twelve Kyocera Management Principles and to enhance their desire to put the Principles into practice.

This education program is composed of a curriculum organized to help trainees conduct active discussion beyond departments, such as the holding of group discussions and wrap-up parties to deepen their understanding of the Twelve Principles. Because leaders understand and implement the Twelve Principles correctly, it is helpful in the promotion of the Philosophy in their workplaces.

Leader Education Curriculum

■ First Leader Education (clarify the purpose and significance of the business)

- Speeches to help better understand the first principle of the Twelve Kyocera Management Principles
 - Set high targets that are fair, just and legitimate.
- Practice of the first principle of the Twelve Management Principles
 - Judgment and action required of leaders
 - Motivating employees, etc.



Leader Education (Kyocera Headquarters)

■ The Twelve Kyocera Management Principles

The Twelve Kyocera Management Principles are fundamental management rules. In other words, they do not change, regardless of any changes occurring in the business environment or conditions. They are the starting point of universal management, and represent the tenets of our management.

1. Clearly state the purpose and mission of your business.
2. Set specific goals.
3. Keep a passionate desire in your hearts.
4. Strive harder than anyone else.
5. Maximize revenues and minimize expenses.
6. Pricing is management.
7. Success is determined by willpower.
8. Possess a fighting spirit.
9. Face every challenge with courage.
10. Always be creative in your work.
11. Be kind and sincere.
12. Always be cheerful and positive.

Philosophy Workshops

The Kyocera Group (Japan) holds Philosophy Workshops to help each employee, regardless of position, age, division or trade, learn the basic Philosophy necessary to do a better job and lead a happy life, and to enhance their willingness to implement the Philosophy. The workshop program introduces familiar case examples about the Philosophy including words and phrases related to the Philosophy spoken by famous people, or the stories of employees about their experience with the Philosophy. In addition, workshop trainees learn the Philosophy from various viewpoints through individual work, group discussion, and watching DVDs. The workshops also help create a sense of unity among group members. In FY2014, workshops were held under the themes of Showing Appreciation and Taking on New Challenges.

Philosophy Workshop Curriculum

■ First Philosophy Workshop (Showing Appreciation)

- Thinking about appreciation
- Noticing appreciation around us
- Showing appreciation

■ Second Philosophy Workshop (Taking on New Challenges)

- Learning the importance of taking on new challenges
- Bracing yourself for challenges.



Philosophy Workshop (Kagoshima Kokubu Plant)

FY2014 Results of Kyocera Philosophy Education

	Leader Education	Philosophy Workshop	Part-timer Workshop
Number of course participants	5,663	21,113	2,861
Training hours and times per employee	Top management 9 hours x 1 Mid-level employees 4 hours x 1	2.5 hours x 2	1 hour x 1

- These programs cover the education provided by the department in charge of Philosophy education at Kyocera. Other education programs include those unique to each department or Group company.
- The education programs planned for FY2015 include Leader Education (twice a year), Philosophy Workshops (three times a year), and Part-timer Workshops (three times a year).

Philosophy Education for Employees of Newly Incorporated Kyocera Group Companies

When a company joins the Kyocera Group, their employees need to learn the Kyocera Philosophy. To help them learn the Philosophy and improve their work, Philosophy Education starts quickly.

In October 2013, the Group provided Kyocera Philosophy Education to all 700 employees of Kyocera Circuit Solutions, Inc. Education started with the history of Kyocera and the necessity of the Kyocera Philosophy, and then programs were carried out for top management, mid-level managers and general employees. These programs successfully deepened understanding of the Kyocera Philosophy.



Education for mid-level employees
(Kyocera Circuit Solutions, Inc.)

Provision of Kyocera Philosophy Education to Overseas Group Companies

The Group holds Philosophy education activities unique to overseas Group companies. A core company is assigned to promote Philosophy education in each of the four regions: Europe, the USA, China and the Asia-Pacific region.

Starting in FY2014, workshops for staff in charge of Philosophy Education are being held at Kyocera headquarters (Kyoto, Japan) to develop personnel capable of planning and operating activities to diffuse Philosophy Education that match local conditions. At the workshop held in April, 22 employees from Group companies located in English-speaking regions participated in the workshop. Along with deepening their understanding of Philosophy diffusion activities, they shared the actual conditions of each area to enhance their sense of cooperation. Last May, a workshop was also held for 10 employees of Group companies in Chinese-speaking regions.

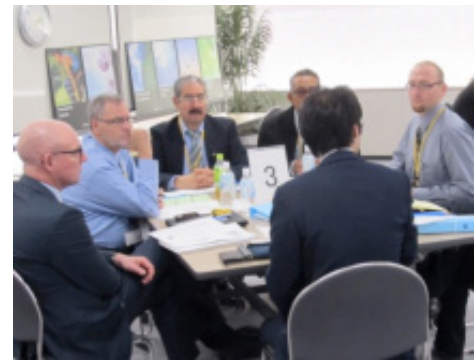

Workshops for personnel in charge of philosophy education

Diffusion Activities Based on Kyocera Group Philosophy Essays

Kyocera has called for submissions of Kyocera Group Philosophy Essays every year since 1990 aimed at having employees deepen their understanding of the need for implementation of the Kyocera Philosophy and mastery of it by linking it to personal experience. In FY2014, a total of about 32,000 essays were submitted from Japan, China and the USA.

Essays submitted by employees are reviewed and the authors of selected essays are awarded the Chairman Emeritus' Prize, the Chairman's Prize or the President's Prize.

A collection of award-winning essays and other excellent essays is issued among the entire Kyocera Group to encourage the practice of the Kyocera Philosophy.



Presentation of Philosophy Essays in China



Collection of Philosophy Essays (Japanese version on the left and Chinese version on the right)

Kyocera Group Corporate Social Responsibility (CSR)

CSR Activities Based on the Kyocera Philosophy

Shortly after its founding, Kyocera adopted its management rationale: “To provide opportunities for the material and intellectual growth of all our employees, and through our joint efforts, contribute to the advancement of society and humankind.” Management is based on the Kyocera Philosophy, which uses the concept “What is the right thing to do as a human being?” as its decision-making criterion. This also forms the basis for the Kyocera Group’s CSR activities.

Through implementation of the Kyocera Philosophy, we work to find solutions to corporate citizenship issues, build relationships of mutual trust with our stakeholders, and aim for the sustained development of the Kyocera Group. At the same time, we endeavor to contribute to the healthy development of society.



Kyocera Group CSR Guidelines

Kyocera Group establishes the Kyocera Group CSR Guidelines, our standards of corporate conduct, and will act towards the creation of a sustainable society.

Introduction

Since its foundation, Kyocera has declared that it will "provide opportunities for the material and intellectual growth of all our employees, and through our joint efforts, contribute to the advancement of society and humankind" as its management rationale and has managed its business based on the Kyocera Philosophy — the core of management in the Kyocera Group. By practicing the Kyocera Philosophy on a daily basis, we will contribute to the sound development of society as well as build mutual trust with stakeholders, and continuously develop the Kyocera Group.

We therefore establish the Kyocera Group CSR Guidelines, our standards of corporate conduct, and will act towards the creation of a sustainable society.

These guidelines apply to Kyocera Corporation and Kyocera Group companies, as well as all executive officers and employees.

1. Basic duties

We shall observe laws, regulations and corporate rules, have unshakable moral values based on the Kyocera Philosophy and perform corporate activities globally, making decisions based on the criterion of "What is the right thing to do as a human being?"

2. Human rights and labor

We shall respect fundamental human rights.

- 2-1. We shall always be aware of changes in work environments and the characteristics and culture of each country to build up a personnel system that can respond appropriately.
- 2-2. We shall respect the human rights of employees and not treat them severely or inhumanely, including abuse or any type of harassment.
- 2-3. We shall promote the creation of attractive, rewarding work environments by attempting to share opinions and information with employees.
- 2-4. We shall respect the right of freedom of association based on the laws, regulations and labor practices of each country.
- 2-5. We shall eliminate forced labor and child labor.
- 2-6. We shall not engage in unfair and discriminatory treatment.

3. Health and safety

We shall observe laws and regulations related to health and safety, fire control, and undertake health and safety measures more actively and continuously including through the implementation of risk assessment and emergency preparedness to provide work environments that are accident and disaster-free, where employees can work in safety and free from anxiety.

4. Environmental conservation

We shall regard the Kyocera Environmental Charter as our guideline for the environmental protection activities to be achieved.

We shall perform improvement activities more actively and continuously to contribute to global environmental protection by working in a comprehensive fashion on environmental measures such as environmental preservation, energy conservation, climate change prevention, resource conservation, global environmental product development and biodiversity conservation. At the same time, we shall communicate those efforts widely to society.

5. Fair trade and ethics

We shall always carry out fair trade in the spirit of equity and fair play.

- 5-1. We shall compete fairly, transparently and freely and carry out fair trade.
- 5-2. We shall arrange and manage a clear import and export management system in accordance with related laws and regulations in Japan and overseas.
- 5-3. When procuring materials, we shall conform to laws and regulations, do business faithfully, justly and fairly without abusing any dominant bargaining position, and work to build up partnerships based on mutual trust.
- 5-4. We shall request business partners to understand and cooperate with our CSR activities.
- 5-5. We shall create, protect and utilize intellectual property rights, respect the intellectual property rights of others, and prevent any violation of their rights.
- 5-6. We shall neither offer nor receive inappropriate profits in relationships with stakeholders.
- 5-7. We shall maintain sound and normal relationships with political organizations and the authorities, and shall never offer bribes or illegal political contributions.
- 5-8. We shall steadfastly maintain an attitude of confrontation with antisocial forces and reject any unjust claim.
- 5-9. We shall carry out activities to prevent wrongdoing and also arrange systems to detect and respond to it immediately.
- 5-10. We shall not purchase any materials or products including conflict minerals or metals derived from them that create a source of funds for armed groups causing human rights violations.

6. Quality and product safety

We shall regard the Kyocera Quality Policy and Kyocera Product Safety Policy as our guidelines to be achieved.

7. Information disclosure

We shall always foster communication with society through appropriate information disclosure and active PR and IR activities; and aim at being a fair, highly transparent and open business enterprise.

- 7-1. We shall strive to disclose information to stakeholders including stockholders and investors quickly, appropriately and fairly; and promote understanding of our management and business activities.
- 7-2. We shall foster fair stock transactions and strive to prevent insider trading such as the buying and selling of stocks based on undisclosed internal information.

8. Information security

We shall be aware that personal information and confidential information are important and strive to prevent information leakages while maintaining and promoting information security.

- 8-1. We shall be aware that personal information is important information that constitutes privacy, and strive to protect it thoroughly.
- 8-2. We shall properly manage and protect confidential information received from customers or third parties, and confidential information of the company obtained in the conduct of business, and prevent any leakage or misuse.

9. Business continuity plan (BCP)

We shall formulate a BCP and aim for quick recovery and operation even if concerns over supply arise due to disaster, etc.

10. Social contribution

Based on awareness that a business enterprise is a member of society, we shall do our duty at all times as a corporate citizen that supports the development of local communities and society, and carry out various social contribution activities, not just business.

- 10-1. We shall actively interact with local people and support sports to contribute to the development of local communities.
- 10-2. We shall strive to do our duty as a member of society through various activities that contribute to society such as education, research, culture, the arts, international exchange and cooperation, and environmental protection activities.

Participation in International Initiatives

The Kyocera Group promotes CSR activities on a global basis by conducting continuous improvement based on international standards including ISO 26000 and the UN Global Compact in order to meet the expectations of stakeholders and establish mutual trust.

ISO 26000

Issued by the International Organization for Standardization in November 2010, ISO 26000 is an international guidance standard concerning social responsibility. This standard is divided into seven core subjects that should be considered in implementation of CSR activities (organizational governance, human rights, labor practices, the environment, fair operating practices, consumer issues, community involvement and development).

UN Global Compact

The United Nations Global Compact is a voluntary undertaking to build a global framework around 10 principles relating to protection of human rights, eradication of unfair labor practices, environmental responses, and prevention of corruption. By participating in the Compact and practicing accountable and creative leadership, individual corporations and organizations function as good members of society, and aim to achieve sustainable growth.



Human Rights

- 1: Businesses should support and respect the protection of internationally proclaimed human rights.
- 2: Businesses should make sure they are not complicit in human rights abuses.

Labour

- 3: Businesses should uphold the freedom of association and the effective recognition of the right to collective bargaining.
- 4: Businesses should uphold the elimination of all forms of forced and compulsory labor.
- 5: Businesses should uphold the effective abolition of child labor.
- 6: Businesses should uphold the elimination of discrimination in respect of employment and occupation.

Environment

- 7: Businesses should support a precautionary approach to environmental challenges.
- 8: Businesses should undertake initiatives to promote greater environmental responsibility.
- 9: Businesses should encourage the development and diffusion of environmentally friendly technologies.

Anti-Corruption

10: Businesses should work against corruption in all its forms, including extortion and bribery.

Enhance Communication with all Stakeholders

CSR Report Meetings

CSR Economic, Social and Environmental Report Meetings have been held by the Kyocera Group (Japan) each year since FY2005. Their purpose is to raise the level of mutual communication with local communities — important stakeholders for the Kyocera Group.

Factories invite local residents, government representatives, business associates, nearby companies and other people from the community to attend meetings where we provide participants with reports on the economic, social and environmental activities of the Kyocera Group as a whole and of the local facilities; along with exchanging views with the participants on CSR measures. In FY2014, 304 people took part at 10 bases in Japan.

Main Programs of the CSR Report Meeting

(1) Kyocera Group CSR activities

- Report on management rationale, Kyocera Philosophy and business activities
- Report on the Kyocera Group's social responsibility and environmental activities



CSR Activities (Nagano Okaya Plant)

(2) CSR activities and plant visits at each site

- Report on social responsibility and environmental activities at each site
- Plant visit (production processes, environment-related equipment, etc.)



Plant visit (Kyocera Crystal Device Corporation, Head Office)

(3) Meeting for exchange of views

·Exchange of views among participants and Q&A

Questions from Participants

■ Osaka Daito Office



Q. “I understand that you are promoting women’s activities, but could you give us some successful case examples?”

A. “We have established a Women’s Activity Promotion Committee. The Committee conducts activities according to specific themes. Specific activities intended to create working environments friendly to women include the holding of meetings to exchange views among female employees and the issuing of in-house reports at individual workplaces featuring, for example, interviews with female managers or introductions to work-and-child-rearing support systems.”

■ Moka Plant, Kyocera Chemical Corporation



Q. “I would like the Moka Plant to cooperate with local festivals and other events.”

A. “We intend to cooperate actively with local communities to enhance communication with local people.”

Apart from that, we have received opinions and questions from a lot of people.

Goals and Results of CSR Activities

	FY2014 Goals		FY2014 Results	FY2015 Goals
Management Philosophy	<ul style="list-style-type: none"> Education and Diffusion of the Kyocera Philosophy 	<ul style="list-style-type: none"> Establishment of the Committee on Kyocera Philosophy Education 	<ul style="list-style-type: none"> The Group-Wide Philosophy Committee was established to formulate policies on Kyocera Philosophy Education and examine and determine measures on the implementation of the Philosophy. Committee meetings are held regularly (three times in total in FY2014). 	<ul style="list-style-type: none"> Meetings of the Group-Wide Philosophy Committee are to be held regularly to continue education and diffusion of the Kyocera Philosophy.
		<ul style="list-style-type: none"> Reinforcement of training programs for implementation of the Kyocera Philosophy and their expansion to each department and Group company 	<ul style="list-style-type: none"> Kyocera implemented programs provided individually by each department, site or Group company based on the conditions of their specific business activities and common programs that support the individual programs, namely Leader Education and Philosophy Workshops. <p>Participants in Kyocera Philosophy Education: 5,663</p>	<ul style="list-style-type: none"> Improvement of training materials and the reinforcement of Kyocera Philosophy Education programs Kyocera is reinforcing education systems matched to each country and region, including the holding of workshops for overseas personnel in charge of Kyocera Philosophy Education.

			<p>people in Leader Education, and 21,113 people in Philosophy Workshops</p> <ul style="list-style-type: none"> • Kyocera has determined core companies to promote Philosophy Education in each of the four regions of Europe, the USA, China and the Asia-Pacific region, and has started unique Kyocera Philosophy Education activities. 	
Management	<ul style="list-style-type: none"> • Reinforcement of communication with stakeholders towards the creation of mutual trust 	<ul style="list-style-type: none"> • Continued holding of CSR Report Meetings 	<ul style="list-style-type: none"> • Kyocera held CSR Report Meetings to further activate two-way communication with local communities (at 10 sites with a total of 304 participants) 	<ul style="list-style-type: none"> • Kyocera will promote communication with local communities through CSR Report Meetings, etc.
	<ul style="list-style-type: none"> • Realization of highly transparent corporate governance and internal control systems 	<ul style="list-style-type: none"> • Improvement of corporate governance systems and internal control systems. 	<ul style="list-style-type: none"> • Corporate governance and internal control systems are maintained to ensure the soundness and transparency of management 	<ul style="list-style-type: none"> • Improvement of corporate governance systems and internal control systems

			<ul style="list-style-type: none"> • Outside directors have been appointed to enhance advice for management and supervisory functions. 	
		<ul style="list-style-type: none"> • Implementation of internal control audits based on the risk approach 	<ul style="list-style-type: none"> • Kyocera implemented internal control audits and accounting audits on internal control systems from the risk approach perspective. Transparency and workability were improved by the evaluation of effectiveness. 	<ul style="list-style-type: none"> • Implementation of internal control audits and accounting audits based on the risk approach
Respect for Human Rights / Optimal Work Environment	<ul style="list-style-type: none"> • Promotion of measures relating to human rights 	<ul style="list-style-type: none"> • Continued implementation of awareness enhancement activities for employees and legal audits that check legal compliance 	<ul style="list-style-type: none"> • Kyocera implemented educational activities on human rights and labor through morning meeting presentations on human rights and labor and readings on related issues from the Kyocera Employee's Action Guideline, which is distributed to all employees. 	<ul style="list-style-type: none"> • Continue implementation of awareness enhancement for employees and legal audits that check legal compliance.
			<ul style="list-style-type: none"> • Kyocera examines compliance with human rights thoroughly. 	

			Human resource departments have implemented voluntary checks and audit departments have also conducted legal audits to see whether there were any legal violations or appropriate management based on labor-related laws, in-house regulations and labor agreements with labor unions.	
<ul style="list-style-type: none"> • Promotion of respect for diversity / work-life balance 	<ul style="list-style-type: none"> • Improvement of measures for the promotion of diversity and support of a work-life balance. 	<ul style="list-style-type: none"> • Briefing sessions on relevant systems were held for employees planning to take maternity leave and meetings were held for exchanges with employees currently on maternity leave to reinforce support for the balancing of child-rearing and work. 	<ul style="list-style-type: none"> • Improvement of measures for the support of work-life balance. • Reinforcement of measures towards the improvement of the rate of employment of disabled persons 	
	<ul style="list-style-type: none"> • Expansion of awareness enhancement activities towards the promotion of female employees 	<ul style="list-style-type: none"> • Women's Activity Promotion Committees set up at each site took the initiative in holding lecture events and meetings for 	<ul style="list-style-type: none"> • Reinforcement of awareness enhancement activities towards the promotion of female employees. 	

		exchanges of views with female employees from other companies and career design workshops, etc.	
<ul style="list-style-type: none"> • Reinforcement of measures on human resource development 	<ul style="list-style-type: none"> • Kyocera implemented training and support measures to help employees learn foreign languages. 	<ul style="list-style-type: none"> • Kyocera implemented measures to support employees acquiring English with the goal of a TOEIC score of 600 • Workshops were held for employees to learn business document writing or presentation methods in English or Chinese to develop engineers who can be active globally (776 participants) 	<ul style="list-style-type: none"> • Kyocera will expand English learning support measures to Group companies.
<ul style="list-style-type: none"> • Reinforcement of management on health and safety and fire and disaster prevention 	<ul style="list-style-type: none"> • Reduction of occupational accidents. 	<ul style="list-style-type: none"> • Kyocera implemented activities to reduce industrial accidents such as the holding of Safety Dojo and Hands-on Experience Dojo events, visits to plants, and joint environmental safety meetings. 	<ul style="list-style-type: none"> • Continuation of measures to ensure the safety of mechanical equipment and safety education for employees towards the prevention of industrial accidents

	<ul style="list-style-type: none"> • Reinforcement of earthquake countermeasures 	<ul style="list-style-type: none"> • Kyocera conducted disaster prevention drills in coordination with fire departments, and simulation drills to rescue people trapped when elevators stop due to earthquakes. 	<ul style="list-style-type: none"> • Kyocera prepared a policy for earthquake response measures, including the fixation of equipment and securement of backup power supplies, and is implementing such measures sequentially. • Continuation of disaster prevention drills in coordination with fire departments
	<ul style="list-style-type: none"> • Revision of the action plan on new types of influenza 	<ul style="list-style-type: none"> • Revision of the action plan to match the revised government guideline • The action plan has been expanded to major production sites in China and anti-influenza measures matching local conditions formulated. 	Expansion to other overseas Group companies
	<ul style="list-style-type: none"> • Revision of education and guidance on employee health management 	<ul style="list-style-type: none"> • Mental health education has been revised. Managers' roles and specific response 	<ul style="list-style-type: none"> • Continuation of mental health education

			methods to affected employees have been clarified, and mental health education is being provided at each site.	
		<ul style="list-style-type: none"> Reinforcement of systems for improvement of 5S levels 	<ul style="list-style-type: none"> Kyocera has established a system to implement 5S Evaluation Education aimed at developing personnel capable of accurately evaluating the 5S of each workplace to enable the appropriate evaluation of 5S activities. 	<ul style="list-style-type: none"> Reinforcement of measures to improve the level of evaluation of 5S activities
Environmental Activities	<ul style="list-style-type: none"> Achievement of Environment Vision 2020 	<ul style="list-style-type: none"> Promotion of activities towards the achievement of a Low-Carbon Society Contribution Factor of 3 in 2020 	<ul style="list-style-type: none"> Low-Carbon Society Contribution Factor: 1.21 	<ul style="list-style-type: none"> Continuation of activities towards the achievement of a Low-Carbon Society Contribution Factor of 3 in 2020
	<ul style="list-style-type: none"> Promotion of environmentally friendly products 	<ul style="list-style-type: none"> Development of environmental products and operation of the Green Supplier Certification System. 	<ul style="list-style-type: none"> Kyocera is developing environmentally friendly products (ratio of environmental products: 99%) Kyocera has revised the Green Procurement Guideline, and 	<ul style="list-style-type: none"> Kyocera will continue to develop environmentally friendly products. Kyocera has implemented a survey based on the Kyocera Guideline on

		<p>established the Kyocera Guideline on Environmentally Hazardous Substances and the Kyocera Guideline on Environmental Protection Activities.</p> <ul style="list-style-type: none"> • The guidelines were distributed to about 450 customer companies and a survey was conducted on contained chemical substances. 	<p>Environmental Protection Activities and is reinforcing the Green Procurement promotion system.</p>
<ul style="list-style-type: none"> • Promotion of environmental awareness at plants and offices 	<ul style="list-style-type: none"> • Kyocera has achieved unit improvement rates of at least 1% compared to FY2013 levels in greenhouse gas emissions, energy consumption, water consumption and industrial waste discharge at all production sites. 	<ul style="list-style-type: none"> • Greenhouse gas emissions basic unit: 3.1% improvement relative to FY2013 • Energy consumption basic unit: 10.2% improvement relative to FY2013 • Water consumption basic unit: 0.3% improvement relative to FY2013 • Industrial waste discharge basic unit: 14.1% improvement relative to FY2013 	<ul style="list-style-type: none"> • Achievement of unit improvement rates of at least 1% against FY2014 levels in greenhouse gas emissions, energy consumption, water consumption, and industrial waste discharge at all production sites

	<ul style="list-style-type: none"> • Environmental communication with local communities 	<ul style="list-style-type: none"> • Reinforcement of environmental communication through the support of children's environmental education, biodiversity preservation and participation in environmental events 	<ul style="list-style-type: none"> • Kyocera provided on-site environmental lessons for children (Participants: 13,460 children at 218 elementary schools in Japan) • Kyocera implemented forestation activities in various parts of Japan including Fukushima, Nagano, Kanagawa, Shiga, Kyoto and Kagoshima. • Participation in environmental events including Earth Expo and recycling events • Kagoshima Sendai Plant received the Award for the Promotion of Measures to Cope with Global Warming. 	<ul style="list-style-type: none"> • Continuation of environmental communication through the support of children's environmental education, biodiversity preservation and participation in environmental events
Fair Business Activities	<ul style="list-style-type: none"> • Promotion of risk management 	<ul style="list-style-type: none"> • Reinforcement of risk management systems 	<ul style="list-style-type: none"> • Kyocera has established a Risk Management Division to restructure risk management systems 	<ul style="list-style-type: none"> • Reinforcement of risk management promotion

		<ul style="list-style-type: none"> • Reinforcement of efforts concerning the Business Continuity Plan (BCP) 	<ul style="list-style-type: none"> • Training for all production departments and environment departments of Kyocera was held (BCP training has been completed for 183 departments in total) • BCP activities based on disaster risks in each area have been conducted actively at various sites. • The Kyocera Supply-Chain CSR Deployment Guideline was revised and Business Continuity Plan (BCP) items were newly added. Kyocera carried out a survey of the state of customers' BCP-related efforts. 	<ul style="list-style-type: none"> • Kyocera will reinforce the deployment of the BCP to overseas Group companies. • Reinforcement of customers' BCP-related efforts
		<ul style="list-style-type: none"> • Reinforcement of efforts related to electronic information security 	<ul style="list-style-type: none"> • Management rules matching local conditions were formulated for Group companies in China and Southeast Asia, and actions were initiated towards the establishment 	<ul style="list-style-type: none"> • Establishment of internal audit systems at Group companies in China and Southeast Asia • Reinforcement of security based on the introduction of

		<ul style="list-style-type: none"> of internal audit systems. • Kyocera has implemented security diagnoses of server systems disclosed outside of the company, such as Web sites, to enhance security. • Kyocera is implementing e-learning on electronic information security. 	<ul style="list-style-type: none"> new authentication infrastructure • Kyocera is continuing e-learning on electronic information security to implement management thoroughly.
<ul style="list-style-type: none"> • Thorough legal compliance 	<ul style="list-style-type: none"> • Establishment of a global comprehensive security trade control system. 	<ul style="list-style-type: none"> • The Security Trade Control (STC) Committee is convened periodically to ensure thorough compliance with import/export laws and regulations • Kyocera has established a security trade control system for overseas Group companies to enhance management. 	<ul style="list-style-type: none"> • Establishment of a security trade control system for overseas Group companies
	<ul style="list-style-type: none"> • Continuing implementation of employee education for thorough legal compliance. 	<ul style="list-style-type: none"> • Kyocera is implementing e-learning on personal information protection for newly employed staff 	<ul style="list-style-type: none"> • Provision of employee education on the prevention of insider trading based on revised laws

	<ul style="list-style-type: none"> • Reinforcement of the audit system on legal compliance. 	<ul style="list-style-type: none"> • In addition to audits of the legal compliance of Group companies in Japan, Kyocera is checking the legal compliance systems of Group companies in Asia. 	<ul style="list-style-type: none"> • Establishment of a new legal audit system based on the introduction of business process audits
<ul style="list-style-type: none"> • Reinforcement of supply chain management 	<ul style="list-style-type: none"> • Continued holding of supplier seminars 	<ul style="list-style-type: none"> • Kyocera held Supplier Seminars, to which customers were invited to understand the management policy and business policy of the Kyocera Group, together with a Supplier Fellowship Party (participants: 149 people from 110 companies). • Three customer companies were presented with awards at the Supplier Fellowship Party for special contributions in terms of factors such as quality, price and delivery dates. 	<ul style="list-style-type: none"> • Continue holding Supplier Seminars and Supplier Fellowship Parties • Kyocera has revised and started operating the basic business contract and added CSR provisions.
	<ul style="list-style-type: none"> • Reinforcement of responses to conflict minerals 	<ul style="list-style-type: none"> • Kyocera held briefing sessions on conflict minerals to request the 	<ul style="list-style-type: none"> • Disclosure of information on conflict minerals and continuing investigations

			<p>cooperation of customers with investigations.</p> <ul style="list-style-type: none"> • Answers from customers are being examined and evaluated. 	
Customer Concerns	<ul style="list-style-type: none"> • Efforts towards the raising of quality and customer satisfaction levels 	<ul style="list-style-type: none"> • Kyocera held a meeting of the Kyocera CS Improvement Committee to promote improvement of the CS index* (24% improvement relative to FY2013). 	<ul style="list-style-type: none"> • Meetings of the Kyocera CS Improvement Committee are held once a month to promote the improvement of the CS index (19% improvement relative to FY2013) 	<ul style="list-style-type: none"> • Meetings of the Kyocera CS Improvement Committee are held regularly to continuously promote improvement of the CS index (49% improvement relative to FY2014).
Social Contribution Activities	<ul style="list-style-type: none"> • Promotion of social contribution activities 	<ul style="list-style-type: none"> • Kyocera has implemented activities including the support of academic and research activities, support of cultural and artistic activities, and international exchange and cooperation 	<ul style="list-style-type: none"> • Kyocera supports the Inamori Foundation's Kyoto Prize, an award to honor excellent achievers in three fields: Advanced Technology, Basic Sciences, and Arts and Philosophy. • The Kyocera Museum of Fine Ceramics, which displays the history of Kyocera's technology and examples of advanced technology, underwent a 	<ul style="list-style-type: none"> • Kyocera will continue activities including the support of academic and research activities, support of cultural and artistic activities, and international exchange and cooperation.

			<p>comprehensive renewal.</p> <ul style="list-style-type: none"> • The 2014 Spring Special Exhibition, displaying cultural properties related to Fushimi Ward (Kyoto City), was held at the Kyocera Museum of Art • Solar power generation systems were donated to seven elementary and junior high schools in Tanzania and Uganda. 	
--	--	--	---	--

*Ratio of quality-related losses in and out of the company

Corporate Governance

Corporate Governance and Internal Control Systems

The purpose of corporate governance and internal control in the Kyocera Group is to maintain management soundness and transparency, and to achieve fair and efficient management, through which we aim to realize the Management Rationale of the Kyocera Group. To establish a sound corporate culture, the Kyocera Group implements the following measures through the practice of the Kyocera Philosophy.

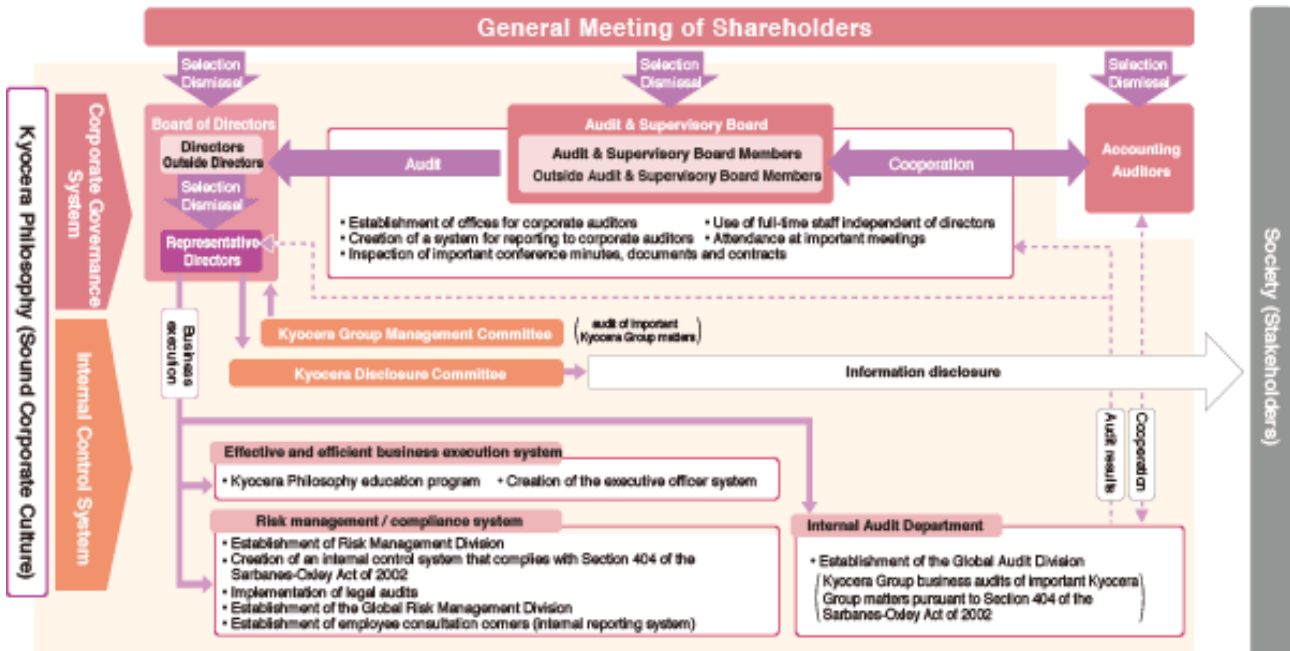

Corporate Governance System

1. Directors shall accommodate requests for reports by corporate auditors.
2. Internal audit departments shall provide regular reports to corporate auditors on the state of internal audits.
3. Establishment of the Kyocera Board of Corporate Auditors Reporting System to enable employees, suppliers, customers and other individuals or organizations associated with the Kyocera Group to report directly to the Board.
4. Corporate auditors have the authority to attend important meetings and to inspect important conference minutes, documents, contracts, etc. Corporate auditors may call for meetings with representative directors to exchange opinions concerning management of the Kyocera Group in general.

Internal Control System

1. Establishment of the Kyocera Disclosure Committee as a means for making timely and appropriate disclosure of management information outside the company.
2. Establishment of a Risk Management Division, as part of the Kyocera Group's risk management system.
3. Establishment of an Employee Consultation Hot-Line Center as part of the Kyocera Group's internal complaint system, where employees can report violations of laws, company regulations or other matters.
4. Introduction of an Executive Officer System to clearly delegate authority and related responsibilities; and construction of an effective and efficient business execution system.

Internal Control Audits of the Kyocera Group

As Kyocera is listed on the New York Stock Exchange, the company is subject to Section 404 of the Sarbanes-Oxley Act. Section 404 requires business operators to construct and maintain internal control systems relating to fiscal reporting. Section 404 assesses the effectiveness of internal control systems through internal audits based on internal control evaluation criteria.

Respect for Human Rights and Diversity

Respect for Human Rights

Aside from compliance with the laws of individual countries, the Kyocera Group implements measures in accordance with the United Nation's Universal Declaration of Human Rights, the Fundamental Human Rights Convention by the International Labor Organization (ILO) and other international conventions. In 2011, the Kyocera Group formally joined the United Nations Global Compact, a global platform setting out 10 fundamental principles relating to human rights, labor, environment and anti-corruption. As stated in these international conventions, the Kyocera Group explicitly prohibits the use of forced labor and child labor, as well as discriminatory treatment on the basis of gender, age, beliefs, nationality, physical features, etc. The Kyocera Group is also working to prevent power harassment and sexual harassment in the workplace.

In addition, the Kyocera Group endeavors to exchange views and share information with employees through organizations such as labor unions and workplace associations. The Kyocera Group promotes development of a comfortable work environment that fosters motivation.

Measures Relating to Human Rights and Labor

To raise employee awareness concerning human rights and labor, time at morning meetings in Kyocera is set aside for announcements on matters requiring compliance in the workplace. Reading in turn about related issues from the Kyocera Employee's Action Guideline, which is distributed to all employees, is also an ongoing activity.

In addition, human resource departments undertake independent checks for legal violations such as discrimination, appropriate payment and working hour management according to labor-related laws and regulations, in-house rules, and labor agreements with unions. Auditing departments also carry out audits regularly to ensure thorough legal compliance.

One Approach

■ Measures for Human Rights in Supply Chain Management

The Kyocera Group policy is not to purchase conflict minerals or materials and products using metals made from conflict minerals, which are a source of revenue for armed groups conducting human rights violations in the Democratic Republic of the Congo and neighboring countries. We are carrying out proactive measures in accordance with this policy.

(see page 111)

Respect for Diversity / Work-Life Balance

Adapting to Globalization

Since Kyocera's first overseas office was established in 1968 (U.S.A.), localization has been the basic principle of recruitment. The Kyocera Group has always tried to appoint local employees to management positions.

We directly employ students who graduate from Chinese universities and graduate schools from the viewpoint of the employment and development of personnel who will lead our global development in the future. We will also continue to employ foreign students studying in Japan.

Ratio & No. of Employees by Region (as of March 31, 2014)

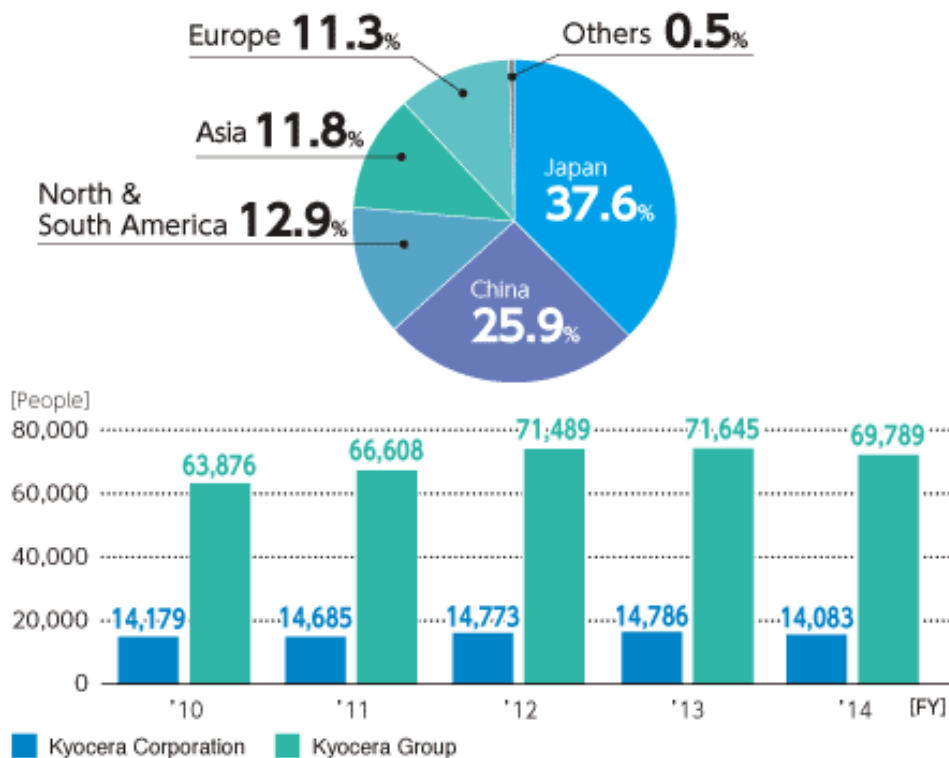

Promoting the Careers of Women in the Workplace

Kyocera views the promotion of women's advancement as an important management task and started efforts in 2006 with the President as the general supervisor. Kyocera actively promotes the creation of a workplace environment that helps a variety of human resources maximize their performance through the promotion of women's advancement activities and ultimately aims to improve corporate competitiveness.

Major actions include improvement of the ratio of female workers, increases in the fields of work available to women, improvement of systems to support female satisfaction of both career and childrearing, and improved awareness of workplace reform.

In particular, awareness improvement activities for workplace reform include the setting up of the Group-Wide Women's Activity Promotion Committee and a Women's Activity Promotion Committee at each site so that various site-specific problems are identified and solved by female representatives selected from each work site serving as committee members

In 2013, a variety of opportunities were provided to expand the frame of reference and viewpoints of women, including lectures by active women, meetings to exchange views with other companies' female employees, and career design training as opportunities for women to design their own future visions. Kyocera also has in place systems to support working women while they raise children and conducts various support activities including the holding of briefing sessions to explain the work-and-childrearing balance system, exchanges of views with other working mothers, and interviews with female workers returning from maternity leave.

Furthermore, a variety of information for awareness of women working in offices is distributed proactively. It is understood that because of these efforts, an environment is gradually being established to help women accumulate work experience and that the number of women serving in leadership positions is increasing.



Women's Activity Promotion Committee (Shiga Yohkaichi Plant)

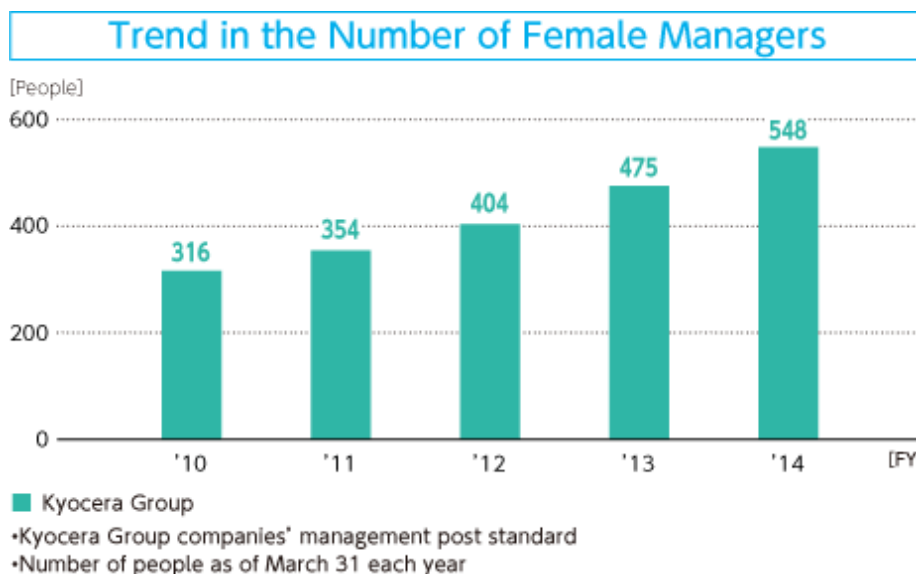

One Approach

■ Kyocera Held Lectures to Support both Working and Childrearing

Female managers, who do an excellent job at work and childrearing at home, were invited to be speak at lectures held in June 2013 at the Gamo and Yohkaichi plants in Shiga Prefecture (Japan). In these lectures, under the theme “fostering an attitude that allows you to blaze your own trail,” the lecturers talked about the working environment surrounding women, their own experiences, and the attitude and thinking necessary to maintain a balance between work and childrearing, while continuing to work positively.



Lectures by female lecturers from outside the company

Opinions of participants

- “Working means contributing to society. I realized that I am one of the people who will support the future of Japan, and I was able to feel proud.”
- “I realized that it is important to find work that you alone can do, that you always have a goal to work towards, and to maintain a broad perspective.”

Employing People with Disabilities

Kyocera focuses on hiring people with disabilities and continuing their employment. Employees with disabilities hired by Kyocera are assigned appropriately so that their jobs and workplaces match their aptitudes. Work environment improvements for employees with disabilities also continue, including elevators and bathroom facilities that are accessible to employees in wheelchairs and braille plates installed at various places to support visually impaired employees. In addition, we provide health care support with the help of occupational health physicians. These fine-tuned responses also help create an attractive work environment for people with disabilities.

In April 2013, the legal employment quota for people with disabilities was revised to 2.0%. In response, Kyocera has developed specific action plans to improve the employment rate and is taking various actions to actively improve the work environment to make it much easier for employees with disabilities to work.

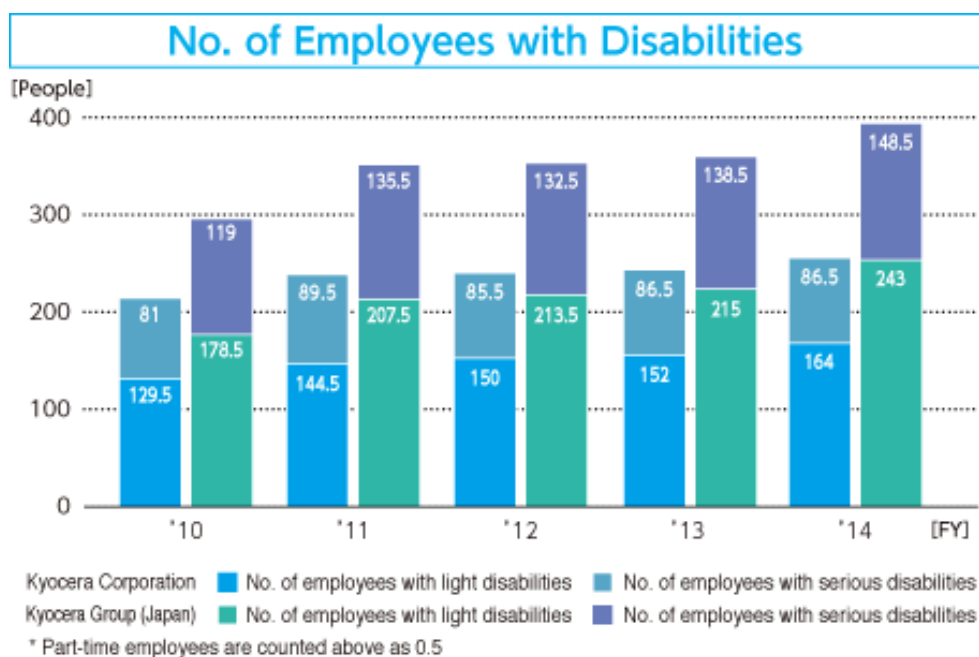

Measures for Child-Rearing and Nursing Care

The Kyocera Group (Japan) introduced the Child-Rearing Leave System, which helps female employees to both work and fulfill their family lives, and in FY2014, a total of 405 female employees used the system. Furthermore, Kyocera has established a Family Nursing Care Leave System, which grants a maximum of one year of leave to employees who need to take care of family members; and the Shortened Workday System, which applies to pregnant employees and employees raising children up to elementary school third graders. A total of 138 employees used these systems in FY2014. In addition, for employees who use baby-sitters, expenses are covered up to 200,000 yen per child per year under Kyocera's baby-sitter use support system. This system is used by employees who would otherwise have had to take time off to send or pick up their children to or from a nursery school or school.

Name of System	Designated by Law	Kyocera Corporation Standard
Family Nursing Care Leave System	3 months	1 year
Shortened Workday System	To starting date of elementary school	To end of elementary school year 3

No. of Employees Taking Child-Rearing Leave

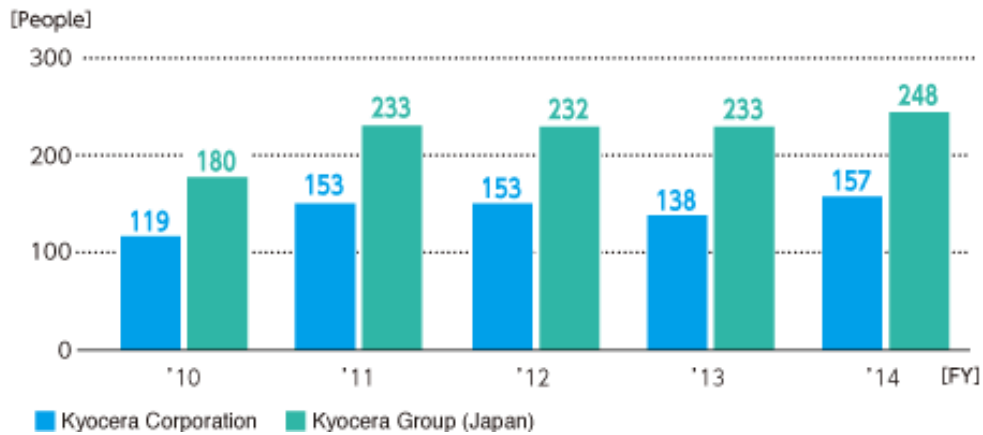

Approaches to Stimulating Communication

Holding Company Events & After-Work Social Gatherings (“Compa”)

The Kyocera Group believes it is necessary to maintain family-like relationships of trust among employees, and thus considers company events and “compa” to be very important.

Kyocera Group “compa” are not simply social gatherings, they are opportunities for interaction aimed at strengthening mutual understanding on reaching specific objectives. This understanding can be attained, for example, by deepening discussion on work-related issues, and by participants declaring their goals.

At company events or “compa,” employees can deepen communication with executives and managers, get to know co-workers in other departments better, and deepen mutual relationships and ties.

Approach to Labor-Management Relations

At Kyocera, great emphasis is put on building relationships based on trust and heart-to-heart bonds among employees. Labor-management relations at Kyocera go beyond the generally accepted idea of harmony between management and labor. At Kyocera, the basis of the relationship is “coaxial labor and management,” where perspectives are shared on the same level. We carry out sports meets, summer festivals and many other kinds of events that stimulate and sustain such relations through unity.

In Europe, the U.S.A., China and other countries, Kyocera continues to maintain appropriate labor relations via thorough labor-management consultation in accordance with labor laws of individual countries. Labor and management on the same axis is the key for successful labor relations. Maintaining this stance will help to resolve problems in the workplace and keep the company on the path of sustainable development.



Sports festival (China)

One Approach

■ Regulations Review Project

The Regulations Review Project, undertaken jointly by labor and management, was launched in 2005. Employees' needs and lifestyles become diversified along with changes in the social climate. Labor and management are therefore working together on checking systems and standards, to ensure they are always appropriate, fair and impartial.

■ Labor and Management Exchange Conference

Meetings of labor and management representatives are held each month in Kyocera plants and offices. The purpose of the meetings is to verify working conditions for employees and the workplace environment, and to actively exchange views on matters needing improvement, among other issues.



Labor and Management Exchange Conference (Headquarters)

■ Kyocera Group Sports Festival

The Kyocera Group Sports Festival is co-sponsored by labor and management in the Kyocera Group to enhance cohesion and relationships of mutual trust throughout the Group via games and victory celebrations. During the 34th All-Sports meet held in 2013, 34 teams that won preliminary tournaments at Kyocera plants, offices and domestic Kyocera Group companies engaged in heated competition.

A Tohoku Select Team was also formed in 2013 to carry on efforts from the previous year to support the restoration of the Tohoku region.

Measures for Raising Workplace Vitality

Kyocera Group (Japan) regularly conducts an awareness survey of all employees. The survey focuses on topics such as the level of satisfaction with work and the workplace environment, the management situation, the sense of trust in the company, and suggestions for improvements. Responses from each organizational unit are analyzed, enabling diagnosis of “vitality level” in each workplace. In 2012, the survey was expanded to include Group companies in Japan. Results of analyses are compiled into a reference index. The index is then used in improvement activities centered on workplace leaders to achieve higher vitality levels in each workplace.

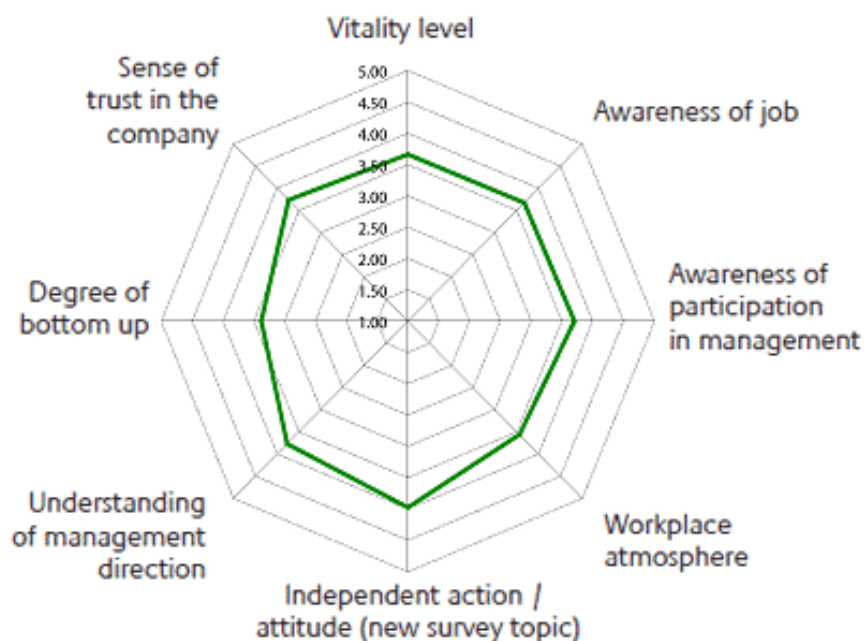

2012 workplace vitality diagnosis results (Kyocera Group in Japan)

Cultivation of Human Resources

Systems for the Cultivation of Human Resources

Kyocera regards human resources as human “assets” and supports activities enabling employees to raise awareness of personal development and their contribution in the workplace. In particular, as personal development can be achieved to a great extent through work, Kyocera is striving to create a workplace environment that enables each employee to work cheerfully and energetically, and draws out natural talents to the maximum extent.

Kyocera helps employees grow based on the following system:

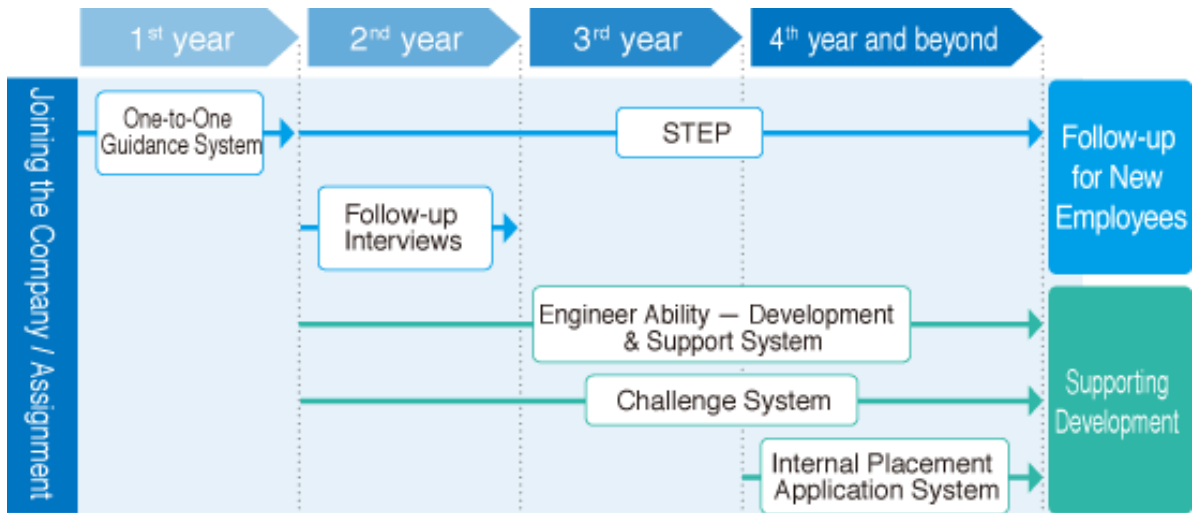

Structure of the Human Resource Development System

One-to-One Guidance System

Kyocera has established a One-to-One Guidance System to support the growth of new employees. Under this system, a guidance manager is assigned to each new employee. Guidance managers undertake close communication with new employees, including periodic interviews, and provide fine-tuned guidance. Follow-up interviews are also provided by human resource departments. New employees therefore enjoy a system that gives them advice from various viewpoints.



STEP

Based on the idea that employees grow steadily step by step as if they go up the stairs and move to the next level, Kyocera established the STEP system for new employees up to the fifth year of employment to support the growth of younger employees. When there are regular opportunities for communication between subordinates and supervising employees, young employees are encouraged to talk about their thoughts and ideas with their supervisors, and the supervisors listen to them and share their thoughts. This creates a feeling of oneness among all employees, which then helps support the growth of young employees.

Skill Development Support System for Engineers

Kyocera has an Engineer Ability Development & Support System to help engineers enhance their credentials independently. This system clarifies the level of roles expected of each engineer and allows engineers to quantitatively understand the skills necessary for their roles. This system leads to improved engineering capabilities for the organization as a whole.

Challenge System

Kyocera also has another system for human resource development, the Challenge System. It allows the sharing of employee work targets with supervisors and improves employee capabilities through interviews with supervisors. This helps employees understand their roles and encourages them to work proactively on their job and skill development. It also aims to create a working environment where every employee can work actively and brightly. Supervisors, by heeding subordinate feedback, endeavor to improve the ability of the organization to reach goals and succeed in business.

Internal Placement Application System

Kyocera's Internal Placement Application System was established to provide employees with information on departments that need personnel immediately, from the corporate viewpoint, for example, due to the start of a new project or expansion of an existing business. Since this system provides employees with various opportunities that allow them to experience different positions at their own will, it serves as an effective means of support for employee career improvement. The optimal assignment of personnel is also another important goal for the company.

Human Resource Education

The Kyocera Group provides human resource education aimed at improving both theoretical and practical aspects of education, understanding and practice of the Kyocera Philosophy and mastering of the specialized knowledge and skills necessary to execute work. Kyocera thus endeavors to optimize human resources who can help us achieve the Management Rationale by providing a variety of education programs based on the education system composed as follows for each objective:

Training Type		Top Management	Mid-Level Employee	Employee	Part-Time Employee	
Philosophy Education	Japan	Philosophy Education by each Department, Site or Group Company				
		Leader Education				
		Philosophy Workshop			Part-Timer Workshop	
	Outside of Japan	Philosophy Education by each Group Company				
		Global Philosophy Seminar		Philosophy Employee Education		
Management Education	Plant Manager & General Office Manager Training	Sales Office Manager Training				
	Training for Department Managers					
		HA* Training				
	Management Skills Training	Administrative Skills Training	Supervisory / Leader Skills Training	Advanced General Skills Training	General Skills Training	
Technical Training		Mid-Level Engineer Training	Specialized Technical Training	Basic Technical Training	Sales Training for New Employees	
Global Education			Overseas Training System			
		Training for Employees Going on Overseas Assignment				
		Training for Improvement of Basic English Skills				

*Human Assessment

Human Resource Education System

Education Results in FY2014

	Management Education	Technical Training	Global Education
No. of Course Participants	2,115 people	3,243 people	804 people
Average Annual Training Hours Per Employee	3 days	1.5 days	1 day

Management Education

Kyocera provides training to supervisors — the leaders of the organization — to develop executives with advanced management capabilities. In addition, Kyocera aims to improve employees' management capabilities by providing the training to employees necessary in each stage of their career development, from the time of entry into the company to mid-level and executive positions, so that they can learn the skills and knowledge required to fulfill their tasks on a step-by-step basis.

Technical Training

It is our goal to develop human resources with a wide range of basic knowledge and advanced expert knowledge in all departments, including engineering, R&D, manufacturing, quality assurance, sales and management. Specific training programs include Basic Technical Training for first year employees, Specialized Technical Training mainly for young engineers, and Mid-Level Engineer Training for mastery of technical management. The training curriculum covers a wide range, such as materials technology, manufacturing technology, production technology, and quality control. Kyocera employees can take the training necessary for their assignments under this training system.



Technical training

Global Education

Kyocera has an Overseas Training System and Overseas Graduate School Study System. The objective of these systems is to cultivate human resources who can function on the global stage. First established in 1984, these systems have sent many employees to various regions around the world, including Europe, China, Southeast Asia, and India as well as the USA. Kyocera is thus promoting the cultivation of employees with improved language skills, the ability to obtain up-to-date knowledge and technology that can only be acquired abroad, as well as enhanced international awareness.

As part of training to improve employees' basic English capabilities, Kyocera has provided English learning support since FY2012 to raise the lowest levels of ability and aid the achievement of a minimum score of 600 points on the TOIEC English test.



Overseas training



English education

Building a Safe & Secure Work Environment

Occupational Health & Safety Policy

The Kyocera Group aims to create an accident-free and disaster-free workplace environment where everyone can work safely and with peace of mind. Based on the policy below, the Kyocera Group is promoting occupational health and safety activities with the participation of all employees:

1. To maintain and improve the level of employee safety and health, the Kyocera Group abides by relevant laws and regulations and establishes and operates internal standards that are stricter than the relevant laws and regulations.
2. The Kyocera Group establishes organizations to effectively promote occupational health and safety activities, and clarifies the functions and responsibilities of those organizations. At the same time, all employees continue to receive necessary and sufficient education and training needed for operation of an Occupational Health & Safety Management System.
3. The Kyocera Group is building and implementing an Occupational Health & Safety Management System, and continually aims to raise the level of occupational health and safety.
4. The Kyocera Group is building and implementing an Occupational Health & Safety Management System, and continually aims to raise the level of occupational health and safety.
5. The Kyocera Group is strengthening mental health care through activities for advancing the mental health of employees.
6. The Kyocera Group actively participates and cooperates in governmental and local activities relating to occupational health and safety.

Approaches to Occupational Safety and Health / Fire and Disaster Prevention

The Kyocera Group promotes various measures to ensure occupational safety and health and the prevention of fire and disaster. Specifically, Kyocera has established a safety and disaster prevention management system for Group companies worldwide based on the Occupational Safety and Health Management System. In Japan, Kyocera conducts continuous improvement activities by conducting risk assessment, realizing improvements, and conducting audits at various sites. Outside Japan, Kyocera aims to further enhance management levels and prevent occupational accidents by holding safety and disaster prevention meetings and carrying out site visits.

One Approach

■ Holding of Safety Dojo and Hands-on Experience Dojo

Two types of hands-on education have been conducted at the Gamo and Yohkaichi plants in Shiga prefecture (Japan) since 2012, the Safety Dojo and Hands-on Experience Dojo, intended to make all employees enhance their safety action awareness and sensitivity to danger.

In the Safety Dojo, participants learn morals and manners for production sites, the effectiveness of the Point and Call practice, and how to conduct risk

perception activities. In the Hands-on Experience Dojo, participants recognize the risks hidden in their daily operations while using a simulator based on past accidents to enhance their awareness of workplace safety. Approximately 2,700 employees have participated in these workshops over the past two years.



Point and Call Training at the Safety Dojo

■ Visits to Plants by Kyocera Headquarters Personnel in Charge of Safety and Disaster Prevention

Kyocera Document Solutions Inc. regularly conducts plant visits in China and Vietnam, with the headquarters personnel in charge of safety and disaster prevention taking the initiative.

When staff members visit a plant, they check hazardous places together with the local supervisor and respond to the hazards while exchanging notes, thereby enhancing the level of sensitivity of the local safety supervisor.

When hazard-related problems are identified, a deadline for creating solutions is determined and the state of response and improvement is regularly checked to promote work environments free of accidents.



Visit to a plant in China

■ Holding of Joint Environment and Safety Meeting in China

Departments in charge of the environment and safety/disaster prevention of major Group companies in China meet regularly at Joint Environment and Safety Meeting in China. They report and discuss actions taken and efforts made to ensure environmental protection and occupational safety at their respective sites and develop future response plans.

In FY2014, about 20 people from Kyocera's major Chinese companies attended the meeting and discussed and exchanged notes on various measures relating to environment and safety. They also held workshops based on the themes of environment and safety to raise the management capability levels of the departments in charge.



Joint Environment and Safety Meeting in China

Kyocera Group (Japan) Safety Record

In FY2014, the safety record of the Kyocera Group (Japan) was good compared with the safety records for overall manufacturing business and electrical machinery and equipment manufacturing business. Specifically, the rate of absence from work due to work-related injuries in the Kyocera Group (Japan) was 0.23% (Kyocera Corporation: 0.22%).

Kyocera strives to prevent occupational accidents and create a work environment where every employee can work safely and with peace of mind.

Rate of Absence Due to Work-Related Injuries

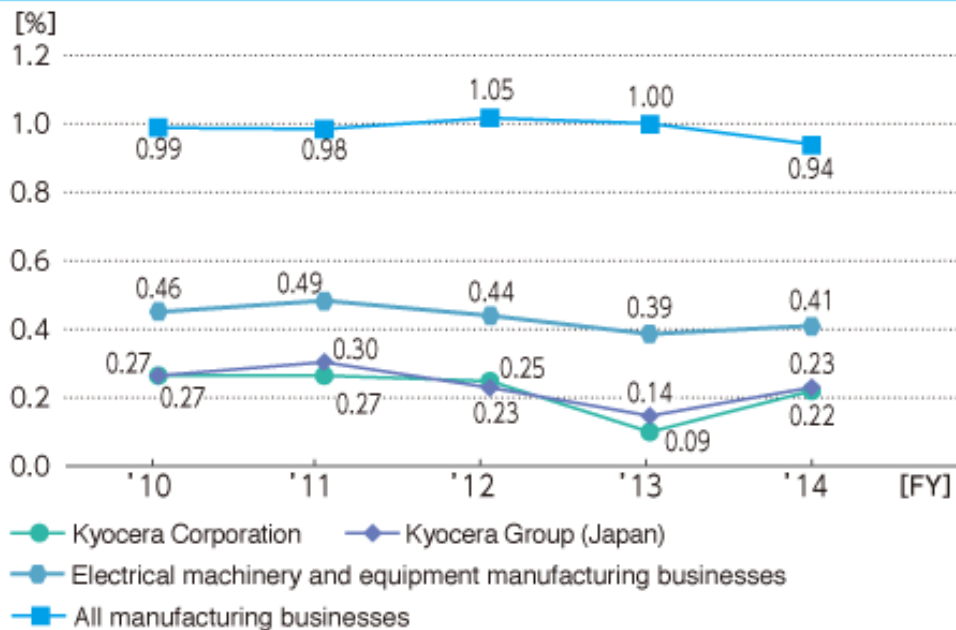

- * Rates of absence due to work-related injuries for all manufacturing businesses and electrical machinery and equipment manufacturing businesses were provided by the Ministry of Health, Labor and Welfare.
- * Work-related injury absence rate: No. of injured / 1,000,000 hours.
Calculation of no. of days' absence is based on standards used by the Ministry of Health, Labor and Welfare (Japan).
- * Work-related injury absence rates produced by the Ministry of Health, Labor and Welfare use calendar year data (absent from work for 4 or more days).
- * Work-related injury absence rates for Kyocera and the Kyocera Group (Japan) are based on fiscal year data (absent from work for 4 or more days).
- * The degree of accident was revised, and some data has been corrected retrospectively.

Promotion of Contingency Planning

The Kyocera Group has formulated a Contingency Planning Manual to minimize human and physical damage and realize early business restoration in the case of a disaster that causes damage in the Kyocera Group. The Contingency Planning Manual specifies rules on information collection and provision, and responses to earthquakes, floods, wind, and volcanic eruption damage based on the Disaster Control Basic Policy.



Contingency Planning Manual index

Actions against Earthquakes

In an attempt to minimize injury and damage from a major earthquake, the Kyocera Group (Japan) is installing a disaster warning system at all plants and offices. This uses the Earthquake Early Warning System provided by the Japan Meteorological Agency. The Kyocera Group endeavors to minimize earthquake damage through diverse means. These include drills using the Earthquake Early Warning System, disaster prevention training for employees, regular disaster drills held with local fire stations and other organizations. Considerable damage is expected from a tsunami that could be generated by an earthquake in the Nankai Trough. To counter the potential damage, evacuation areas have been prepared for bases that are likely to sustain damage, based on the expected maximum tsunami height and shortest arrival time. Steps have been taken to ensure employees are fully aware of what they need to do.

One Approach

■ Implementation of Elevator Rescue Drills

It is possible that customers or employees will be trapped in an elevator following the occurrence of a major earthquake.

The Kyocera Group (Japan) conducts drills to rescue people trapped in elevators to train personnel to smoothly rescue trapped people. In these drills, participants check the position where the elevator stopped and manually open each type of elevator.

These drills are conducted regularly to make employees ready for action in the event of an emergency.



Elevator rescue drill
(Headquarters)

■ Prevention of Secondary Damage from Major Earthquakes

There is a fear that dangerous or toxic substances could leak from damaged pipes following the occurrence of a major earthquake and eventually affect people's health and spread pollution to the surrounding environment. The shutdown of cooling equipment as a result of a power outage could cause secondary damage such as a fire or explosion.

The Kyocera Group (Japan) takes the necessary measures to minimize such secondary damage by fixing mechanical equipment in place. A new action policy on the prevention of secondary damage will be newly established in FY2015 to ensure further safety improvements.

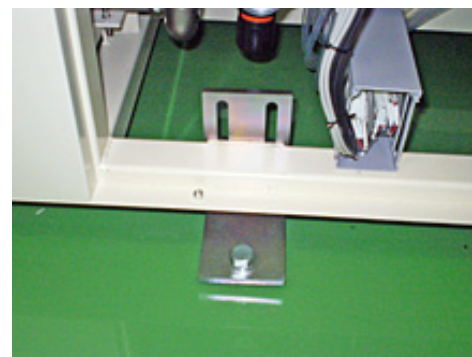

Fixation of equipment

Actions against New Influenza Pandemics

The Kyocera Group (Japan) formulated an action plan for new influenza pandemics in FY2009 in case of the spread of new types of influenza. The action plan sets the prevention of contamination to employees, prevention of the spread of influenza and the minimization of business activity shutdowns as its basic goals, and provides measures to allow the continuation of business activities on the condition that the safety of employees be given top priority. In FY2014, the action plan was revised to cope with the revision of the relevant government guideline. The action plan was also expanded to major production sites in China and anti-influenza measures matching local conditions were promoted.

Approaches to Promotion of Health

The Kyocera Group is undertaking various measures to raise awareness of health among all employees and support health in body and mind. Kyocera has long engaged in diverse activities aimed at improving mental health.

For example, ongoing measures include the assignment of occupational health physicians specializing in mental health at offices, the use of consultants in and out of the company, the study of mental health measures at the In-house Occupational Health Physicians' Meeting, and the introduction of a rehabilitation work system.

Holding of In-house Occupational Health Physicians' Meetings

Kyocera holds In-house Occupational Health Physicians' Meetings twice a year, at which in-house occupational health physicians assigned to Kyocera sites gather for discussions, with the Safety and Disaster Prevention Department taking the lead. The goal of these meetings is to enhance the level of health management services at Kyocera. Participants in the meetings share measures and problems concerning health management and discuss improvement measures and solutions for the future.

Representatives of human resource departments and the health insurance union also attend the meeting. All of these departments and stakeholders combine forces to solve problems and actively promote the health care of employees.



In-house Occupational Health Physicians' Meeting

Provision of Mental Health Education to Supervisors

The Kyocera Group is providing mental health education to prevent psychological problems.

In FY2014, Kyocera revised its mental health education and clarified the roles of supervisors and specific response methods for affected employees. Mental health education based on this revision is currently being provided at each site. We will aim to establish a system that allows the prevention of mental health problems and their early resolution if they do occur.



Mental health education (Headquarters)

Deployment of Kyocera Perfect 5S Promotion Activities

The 5S system (“Seiri”: Sort / “Seiton”: Set in Order / “Seiso”: Shine / “Seiketsu”: Sanitize / “Shitsuke”: Sustain) is at the heart of work. Efforts by the Kyocera Group to implement the 5S system perfectly are called Kyocera Perfect 5S Promotion Activities. They are being introduced globally.

Kyocera has built a system able to carry out 5S evaluations without variation in the Group as a whole by compiling 5S Checklist Evaluation Cases, which contain 5S checklists, photos and illustrations that clarify the judgment standard and develop 5S Evaluators who can inspect 5S at work sites properly. Kyocera will take active measures to further invigorate Perfect 5S Promotion Activities, create a safe and secure work environment, and improve quality and productivity.



5S evaluator education

Kyocera Group Environmental Management

Since foundation of the company, based on the corporate motto “Respect the Divine and Love People,” the Kyocera Group has focused all corporate activities on three pillars of coexistence (Living Together): Coexisting with Our Community, Coexisting with Global Society, and Coexisting with Nature. The entire Kyocera Group is committed to environmental management and aims for sustainable corporate development while striving to combine the goals of ecology and economy.

The Kyocera Group handles many chemical substances during production processes, such as raw materials and chemical agents for fine ceramics. Regarding treatment of waste water from factories, our policy is to purify discharged water to a state cleaner than the water system into which it is to be released.

It is Kyocera Group policy to render any industrial waste as harmless as possible by using the latest technology.

Based on this concept, the Kyocera Group enacted the Kyocera Environmental Charter in 1991, the company’s basic philosophy regarding the environment. Kyocera established its Environment Vision 2020 in order to embody the Kyocera Environmental Charter and define the company’s stance on a long-term basis up to 2020. As a yearly goal to achieve this vision, Kyocera has formulated the “Kyocera Group Global Environmental Policy.”



I. Preface

Technological progress and economic development in industrialized countries have given rise to affluent societies with high standards of living. At the same time, they have led to the mass consumption of natural resources and mass discharge of chemical substances — which, in turn now threaten to escalate environmental pollution and destroy the Earth's ecosystem. In addition, explosive population growth and widespread poverty in developing countries have aggravated these environmental problems with large-scale deforestation. The social and economic activities of both advanced and developing countries are intertwined, and with all parties intent on greater material consumption, nature's recuperative powers have been exceeded. As a result, the Earth's natural regenerative mechanism has been damaged on a global scale.

One of our major premises up to this time — that the Earth's ecosystem is infinitely large — is now being rejected in favor of the idea that the Earth is a closed ecosystem. Such a change in view affects the very foundation of humankind's existence and demands a re-evaluation of the quality and quantity of the products used by humankind. This, in turn, will lead to a fundamental change in the industrial / technological system within which such products are manufactured.

In the course of history, humankind has witnessed three eras of rapid development: the Agricultural Revolution, the Industrial Revolution and the Information Revolution. It is generally felt that the current environmental movement will someday be regarded as humankind's fourth era of rapid development: the Environmental Revolution.

Our future thus requires new policy goals. These should state that development and economic growth may be pursued only when proper consideration is given to the balance between nature and society and environmental conservation. While an individual's impact may be small, the cumulative result from a rapidly expanding population could cause complete environmental destruction.

Therefore it is essential to establish a basic philosophy of coexistence and co-prosperity between the developed and developing countries, between business and government, and between individuals and societies. All must be viewed as participants in the stewardship of "Mother Earth," not as opposing forces with conflicting interests.

The greatest responsibility for promoting the Environmental Revolution lies with the advanced countries. In particular, businesses in such countries play a vital role, as they possess production technologies and are directly engaged in industrial activities.

II. Basic Philosophy

In accordance with our corporate motto — “Respect the Divine and Love People” — since its foundation, Kyocera has adhered closely to its management rationale, “To provide opportunities for the material and intellectual growth of all our employees, and through our joint efforts, contribute to the advancement of society and humankind.” We strive to conduct business in harmony with the life-giving force of our universe. Kyocera had early insight into the mindset that today's global environmental problems make demands of every business enterprise. This mindset implies that business should uphold the dignity of humankind and contribute to the sustainable development of society.

Based on the management rationale stated above, the Kyocera Group adopts comprehensive measures for the creation of a low-carbon producing, sustainable society — a society which exists in harmony with nature — and will further heighten our goals towards environmental protection, development of environmentally friendly products, energy conservation & climate change prevention, resource conservation, waste reduction, proper management of chemical substances, and biodiversity protection in order to make proactive and continuous contributions to environmental preservation.

III. Basic Policies

In the course of business activities, the Kyocera Group will take a serious view of global environmental protection adhering closely to the Company's basic philosophy, stated above, and will emphasize the following points:

1. Adhering to internal environmental standards that make global environmental protection our first priority;
 - (1) In order to minimize impact on the natural environment and any harmful effects on the ecosystem, Kyocera will establish and comply with internal standards which are more stringent than those specified by applicable international agreements and, national laws local regulations where the Company's facilities are located.
 - (2) At all levels, Kyocera will scientifically study and evaluate the effects of business activities on the environment, and then take the necessary protective measures.
2. Kyocera will strive for the development of environmentally friendly products in two categories;
 - (1) Kyocera will increase its research and development of Products for Environmental Improvement that make a positive contribution to the enhancement of the global environment, and strive to spread the use of such products.
 - (2) Kyocera will increase its research and development of Environmentally Gentle Products that have a lighter burden on the environment at each stage of production, sales, distribution, consumption and disposal and strive to spread the use of such products.

-
3. Most efficient utilization of resources and innovation of processing technologies;
 - (1) Kyocera will develop processing technologies and production facilities that have maximum resource and energy efficiency. At the same time, the Company will aim to reduce raw material and chemical consumption in all processes.
 - (2) Kyocera will promote internal energy conservation activities, such as more efficient use of electricity and fossil fuels, the introduction of high efficiency equipment, and the reutilization of waste heat. At the same time, the Company will promote measures for climate change prevention.
 - (3) Kyocera intends to purchase recyclable materials which contribute to resource conservation while maximizing resource efficiency by establishing recycling systems for wastewater and waste materials. The Company will take aggressive steps to reduce the volume of and decontaminate all waste.
 4. Enhancement of environmental communication, participation in, and support for, social contribution activities.
 - (1) Kyocera will pursue education to improve employees' environmental awareness and thus promote participation in environmental preservation.
 - (2) Kyocera will broadly establish cooperative relationships with local communities, municipalities and business partners to promote positive environmental communication.
 - (3) Kyocera will promote the "greenification" (tree-planting) of its facilities in an organized effort to create grounds which are lush and inviting. At the same time, the Company will participate in and support social contribution activities.

IV. Promotion Organization

1. Kyocera will establish and operate an environmental management system based on ISO 14001 standards, and continuously expand environmental preservation activities.
2. To ensure compliance with legal and governmental environmental regulations, and internal environmental standards, an internal review group will conduct audits on both a regular and an as-needed basis.
3. The Environmental Management Division, facility manager and environmental specialists will implement an independent auditing system regarding environmental protection at each of its business locations.

V. Application

The Kyocera Environmental Charter will be applied to companies within the global Kyocera Group.



For the Kyocera Group, harmonious coexistence (Living Together) is the underlying foundation of all our business activities as we strive for sustainable development through environmental management. Based on a global environmental management system (Green Management), we strive for ecological and economic compatibility in three areas: Green Products, Green Factories, and Green Communication

1. Contribute to realization of a low-carbon society

Targeting a Low-Carbon Society Contribution Factor of 3 (Contribution Volume / Emission Volume) by maximizing the reduction of greenhouse gas emissions through energy creation, and suppressing greenhouse gas emissions in business activities.

2. Contribute to realization of a recycling-based society

Contribute to realization of a society with sustainable recycling of resources by reducing the volume of new resource input and minimizing waste.

3. Contribute to realization of a society coexisting with nature

- (1) Advance conservation of biodiversity by minimizing negative impact on the natural environment, as well as protecting and nurturing the natural environment.
- (2) Contribute to cultivation of an environmentally conscious society, through environmental communication with various stakeholders and environmental awareness activities.

Commitment to Achieving a Low-Carbon Society

In addition to targets for reducing greenhouse gas emissions from business activities, the Environment Vision 2020 establishes a benchmark in aiming for realization of a low carbon society. Named the Low-Carbon Society Contribution Factor, this benchmark gives an overall assessment of the volume of contribution to greenhouse gas reduction through use of Kyocera Green Products.

■ Low-Carbon Society Contribution Factor Calculation Method

$$\text{Low-Carbon Society Contribution Factor} = \frac{\text{Volume of contribution to greenhouse gas reduction}^{*1}}{\text{Volume of greenhouse gas emissions}^{*2}}$$

*1 The volume of contribution to greenhouse gas reduction is obtained by converting the volume equivalent to the energy creation effect into the greenhouse effect gas, in which the photovoltaic systems produced and marketed are assumed to continue power generation for 20 years. In addition, the coefficient used in conversion shall be 0.360kg of CO₂ per kWh (based on the Japan Photovoltaic Energy Association's Independent Industry Rules on Labeling).

*2 Greenhouse gas emissions at manufacturing sites of the Kyocera Group. The values have been corrected retrospectively as the subjects of calculation were newly limited to manufacturing sites only.

■ Result of Low-Carbon Society Contribution Factor

FY	'09	'10	'11	'12	'13	Target
Factor	0.60	0.73	1.04	1.05	1.21	FY2020: 3.00

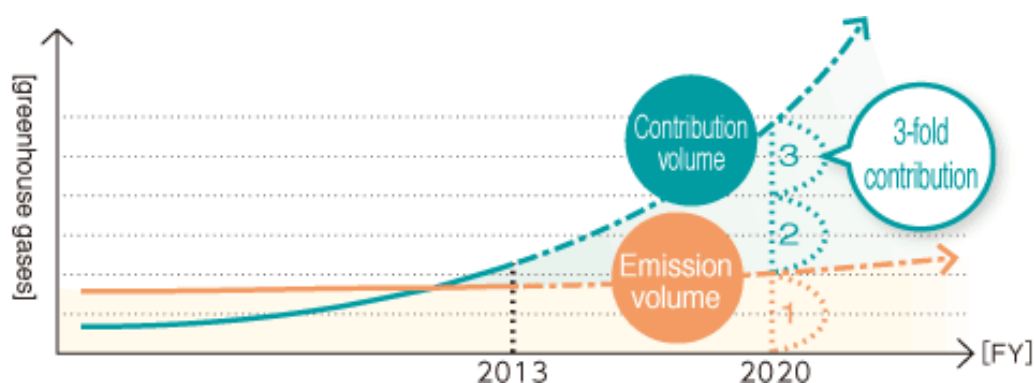

* For this page only, fiscal years (FY) are counted in the style of Japan, where the fiscal year is represented by the year in which it begins (April 1).

Participation in the Low-Carbon Society Action Plan

Kyocera participates in the electric and electronic industries' Low-Carbon Society Action Plan to fulfill our contribution to the realization of a low-carbon society. To be specific, what we attempt to achieve by 2020 includes reductions in CO₂ emissions by 1% annually on average in energy basic units and reductions in CO₂ emissions in products. Our efforts are in concert with the industry's commitment to climate change prevention.

Kyocera Group Global Environmental Policy

The Kyocera Group has established the Kyocera Group Global Environmental Policy, which sets yearly targets to be attained in the four areas of greenhouse gases, energy, water, and industrial waste.

In all production sites, the greenhouse effect gas emissions, energy consumption, water consumption, and industrial waste discharge will be reduced by 1% or more from a year earlier in terms of energy consumption unit improvement rate.

Green Management: Basis of Environmental Management Promotion

Environmental Management Promotion System

The Kyocera Group formulates environment-related policies and measures through reviews and discussions in the Planning and Policy Division, Environment Division and other related divisions with the President as leader. Environment-related projects are set up whenever required to take on any environment-related challenges and resolve outstanding issues.

A separate organization has been established with the Environment Division playing a central role so that Kyocera can continue activities for environmental protection. Specifically, the contents of the Kyocera Group Global Environment Policy are assimilated into our environment management system based on ISO 14001 and managed through the monthly PDCA process.

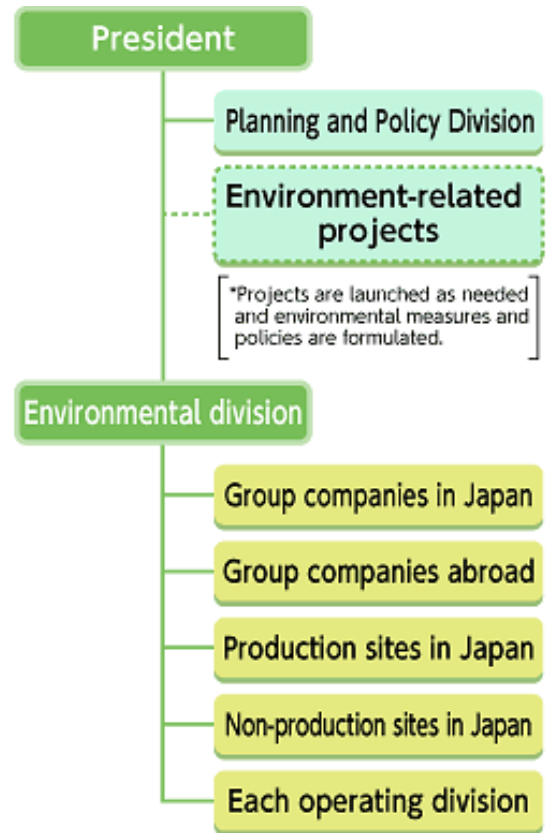

Environmental management promotion system

Environmental Education

The Kyocera Group provides systematic environmental education to help all employees understand the significance of environmental protection activities and their roles in them. Specifically, environment education is divided into general/awareness education and special education and is provided to employees systematically depending on their rank and occupation so as to improve environmental awareness.

		Top Management	Mid-level Employee	Employee	Part-time Employee
General / Awareness		Employee magazine, Web site, various monthly activities, etc.			
Specialty	By hierarchy	Plant Manager & General Office Manager Training	Sales Office Manager Training	Education for section chiefs Supervisory / Leader Skills Training	Education for new employees
	By function	Education for environmental safety directors	Education for department managers Education for environmental safety managers	Education for environmental enhancement leaders	Education for environmental enhancement personnel
	Technique	(Other: Education for employees of in-plant resident companies, education for vendor companies)			Education for personnel engaging in specific environmental jobs Basic environmental technology program
	Certification	Education for chief internal environmental safety auditors	Education for internal environmental safety auditors	Training of lecturers for "Eco-Lessons"	

Efforts to Improve Employees' Environmental Awareness

The Kyocera Group sets a specific period in which environmental protection activities such as energy conservation are conducted intensively so as to improve awareness of the environment and enhance environmental conservation activities at plants and offices.

In Japan, the period of four months from June to September was designated Summer Eco Challenge 2013 as a movement to intensify efforts for energy saving during summer. Kyocera conducted various activities during this period, including a "Green Curtain" photo contest and Eco-Lessons for the children of Kyocera employees.

Overseas, Kyocera also carried out active efforts including the preparation of environmental awareness posters and participation in local environment-related events.



Environment-awareness poster (Thailand)



Participation in environmental events (Mexico)

Environmental Risk Management

The Kyocera Group established the Kyocera Group Environmental Management Standard in 1992, which is stricter than statutory and public regulations on emissions, wastewater, soil and groundwater. Based on this Environmental Management Standard, we have more stringent voluntary management standards for each site. Thorough management for environmental conservation is thus ensured using these strict standards, including periodic environmental measurement. In addition, we have Soil and Groundwater Management Regulations to ensure the prevention of soil contamination. To comply with these regulations, we take various measures, including the use of double wall structures for underground storage tanks and leakage detection systems to promote early detection of leaks and prevention of the spread of contamination.

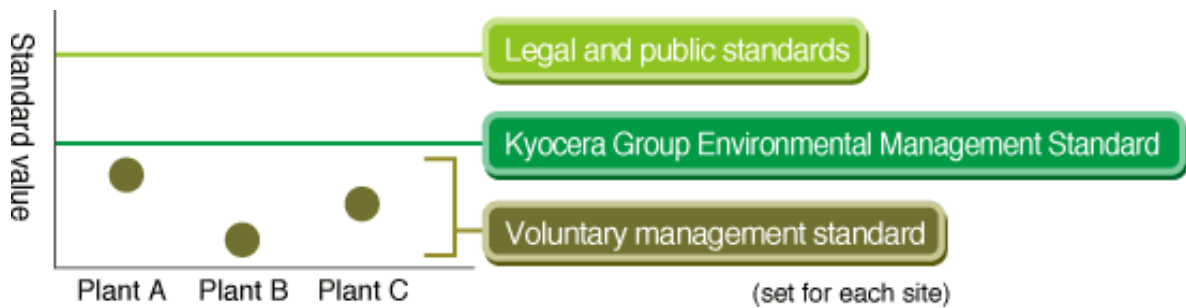

Kyocera Group Environmental Management Standard

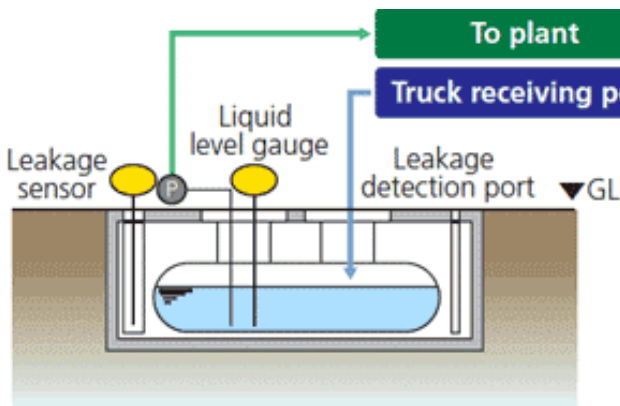

Double-layered underground tank storage

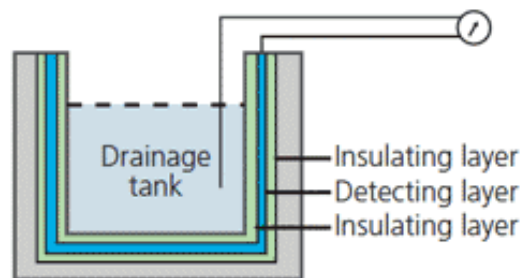

Leakage detection system
(Leakages are detected by sensing changes in electric resistance as a result of damage to the insulation layer.)

Dealing with Emergencies

Assuming the inevitability of accidents and emergencies which may affect the environment, we have taken preventative countermeasures, such as the installation of dikes. We have also prepared procedures for dealing with emergencies. To ensure that employees are familiar with these procedures, we hold emergency training drills more than once each year.



Emergency training (Kagoshima Sendai Plant)

Environmental Regulations Compliance Status

In the Kyocera Group, no violations of environment-related legal regulations occurred in FY2014.

■ Reports on Soil and Groundwater Contamination

The Kyocera Group (Japan) conducts soil surveys based on the Soil Contamination Countermeasures Act and provides survey reports to the relevant local governments. Four sites have so far been designated by local authorities as warning areas, one location of Kyocera Crystal Device Corporation in Asahi City, Chiba Prefecture in 2013, two sites of Kyocera Crystal Device Corporation in Ebetsu City, Hokkaido Prefecture and Hachioji City, Tokyo, in 2014, and one site of Kyocera Chemical Corporation in Kawaguchi City, Saitama Prefecture in 2014.

Strict control of contaminants is now being carried out at these sites, including measures to prevent the spread of contamination. No spreading or effects on surrounding areas have so far been reported. Kyocera will continue to work with local authorities and take appropriate measures to prevent pollution.

Environmental Audit

The Kyocera Group conducts periodic internal audits to make sure the Environmental Management System is being run properly based on the requirements of ISO 14001.

The results and corrective actions are reflected in the review and in the improvement of the Environment Management System.



Environmental audit

Environmental Accounting

The Kyocera Group established an Environmental Accounting System which has been in practice since FY2003. In its business activities, the Kyocera Group quantitatively assesses the cost laid out for environmental conservation and its conservation effects as well as economic benefits, and positively utilizes this information for environmental conservation measures.

Range of data collection: 185 sites

Sites collectively certified under the Kyocera Group Integrated Environment & Safety Management System

Period covered: April 2013 through March 2014

Guideline for reference: Ministry of the Environment's "Environmental Accounting Guidelines 2005"

· Overseas sites were removed from the scope of management in the summation of FY2014. (Applied retrospectively to the FY2013 summation)

Environmental Accounting Analysis Results (FY2014)

Environmental conservation costs (total of investment and expenditure) were ¥5,658 million in total as a result of the additional installation of solar power generation systems at the Nagano Okaya Plant, Shiga Yasu Plant, and Kagoshima Kokubu Plant, as well as investments on energy-saving activities at various plants.

Economic effects resulting from environmental conservation effects were ¥9,235 million in total as a result of reductions in industrial waste and the introduction of highly efficient equipment.

Concept of Environmental Accounting

Double reporting of internal transactions is prevented in companies subject to data collection. For Group companies with an equity ratio not equal to 100%, data collection is performed by regarding the investment amount, expense amount, and environmental conservation effects as 100%.

Concept of Environmental Conservation Costs

For environmental conservation facilities, the investment amount and running costs are totaled. For environmental conservation activities, the expenses spent for such activities are totaled. Research and development costs included in costs for environmental conservation are included in fundamental research and development.

Definition of Environmental Conservation Effects and Economic Benefits

The economic benefits of environmental conservation efforts are computed only for cases in which there is clear, quantifiable evidence of an improvement in environmental conservation. The economic effects as a result of environmental conservation measures for research and development costs are not computed.

Environmental Conservation Costs

(Unit: Million yen)

Cost Classification	Investment		Cost	
	FY2013	FY2014	FY2013	FY2014
Business area costs	513	1,112	4,601	3,638
Pollution prevention costs	308	87	2,517	2,003
Global environmental conservation costs	183	1,024	1,045	591
Resource recycling costs	22	1	1,039	1,044
Upstream / downstream costs	0	0	219	182
Management costs	3	1	673	672
R&D costs	-	-	-	-
Social activity costs	0	0	38	52
Environmental remediation costs	0	0	2	1
Total	516	1,113	5,533	4,545

Economic Effects of Environmental Preservation Measures

(Unit: Million yen)

Item	FY2013	FY2014
Income	2,295	2,043
Cost-cutting measures	5,788	7,192
Total	8,083	9,235

Cost-Effectiveness

(Unit: Million yen)

Item	FY2013	FY2014
Cost	5,533	4,545
Economic effects resulting from environmental preservation measures	8,083	9,235
Cost-Effectiveness	2,550	4,690

Environmental Conservation Effects

Effect Content	FY2013	FY2014	Unit
Reduction of electricity	73,057	106,634	MWh
Reduction Tons- CO ₂ of fuel	11,565	8,471	kℓ (crude oil equivalent)
Reduction of greenhouse gases such as PFC	9,257	9,420	Ton-CO ₂
Reduction of water usage	23,608	34,564	1,000m ³
Reduction of chemical substances	5,447	6,161	Tons
Reduction of waste	35,455	74,131	Tons

Overall Environmental Impact

The Kyocera Group monitors and manages the relationship of business activities and environmental burdens as numerical data. The data for each stage of materials procurement, manufacturing, distribution, use, and disposal/recycling are used in the formulation of measures and the analysis and assessment of results to realize effective reductions in environmental burdens.

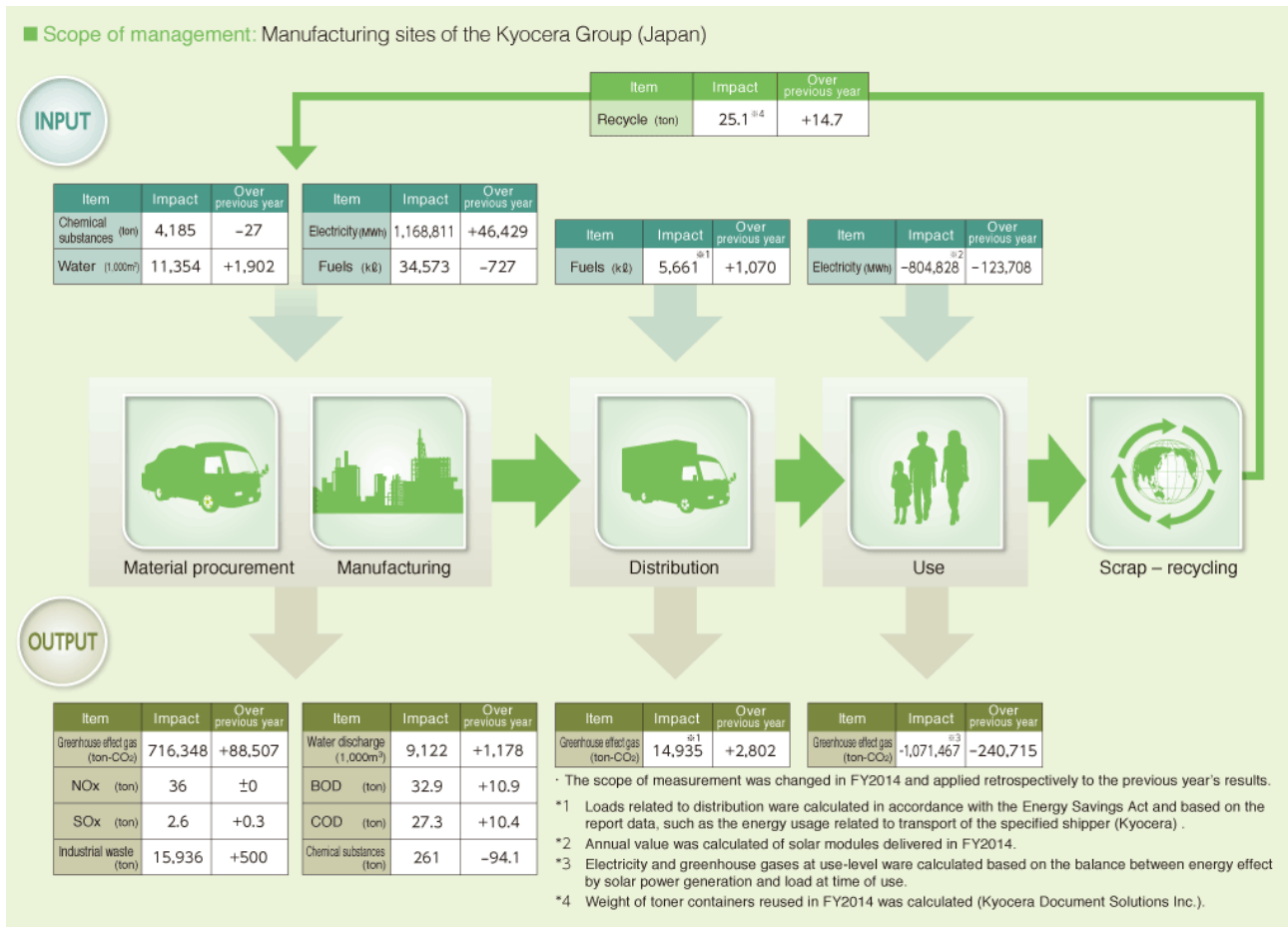

Input Items

Chemical substances	Amount of used Chemical substances specified by PRTR (Class 1 Chemical substances)
Water	Amount of city water, industrial water and groundwater consumption
Electricity	Electricity purchased from electric power companies
Fuels	Amount of fuels used as energy, such as LPG, light oil, and heavy oil (crude oil equivalent)

Output Items

Greenhouse gases	Amount of 6 major gases discharged, including CO ₂ and PFC, as a result of electricity, gas and fuel consumption
NOx	Amount of nitrogen oxides discharged from gas and fuel consumption
SOx	Amount of sulfur oxides discharged from gas and fuel consumption
Industrial waste	Amount of discharged industrial waste generated by business Activities
Water discharge	Amount of discharged water into rivers (except water discharged to sewage system)
BOD	Load of discharged biochemical oxygen demand
COD	Load of discharged chemical oxygen demand
Chemical substances	Release and transfer amount of chemical substances specified by PRTR (Class 1 chemical substances)

Green Products: Environmentally Friendly Products

Development of Environmentally Friendly Products

The Kyocera Group aims for every product that it sells to contribute to the betterment of the global environment and endeavors to develop environmentally friendly products.

Kyocera has clearly specified the Concept of Environmental Consciousness to guide our design of environmentally conscious products. Kyocera also identifies products designed to contribute actively to the climate change prevention, energy saving, resource saving, and reductions in hazardous substances as Green Products, and has set up evaluation criteria for each product based on the Concept of Environmental Consciousness. As a result of these efforts, 99% of our products were designated as Green Products in FY2014.

We intend to continue being active in this respect to continue supplying environmentally friendly products to society.

Concept of Environmental Consciousness

Kyocera considers the three themes of "Climate Change Prevention and Energy Conservation," "Resource Recycling" and "Environmental Preservation and Safety" as high-priority issues. For each of these, we have established clear guidelines for environmental protection at the product development stage.

■ Concept of Contributing to Environmental Protection

These products allow customers and end-users to contribute to the reduction of environmental impact through use of our products.

■ Concept of Lowering Environmental Impact

These products minimize environmental impact at all stages of the product life cycle, including manufacturing, sales, distribution, use, and disposal.

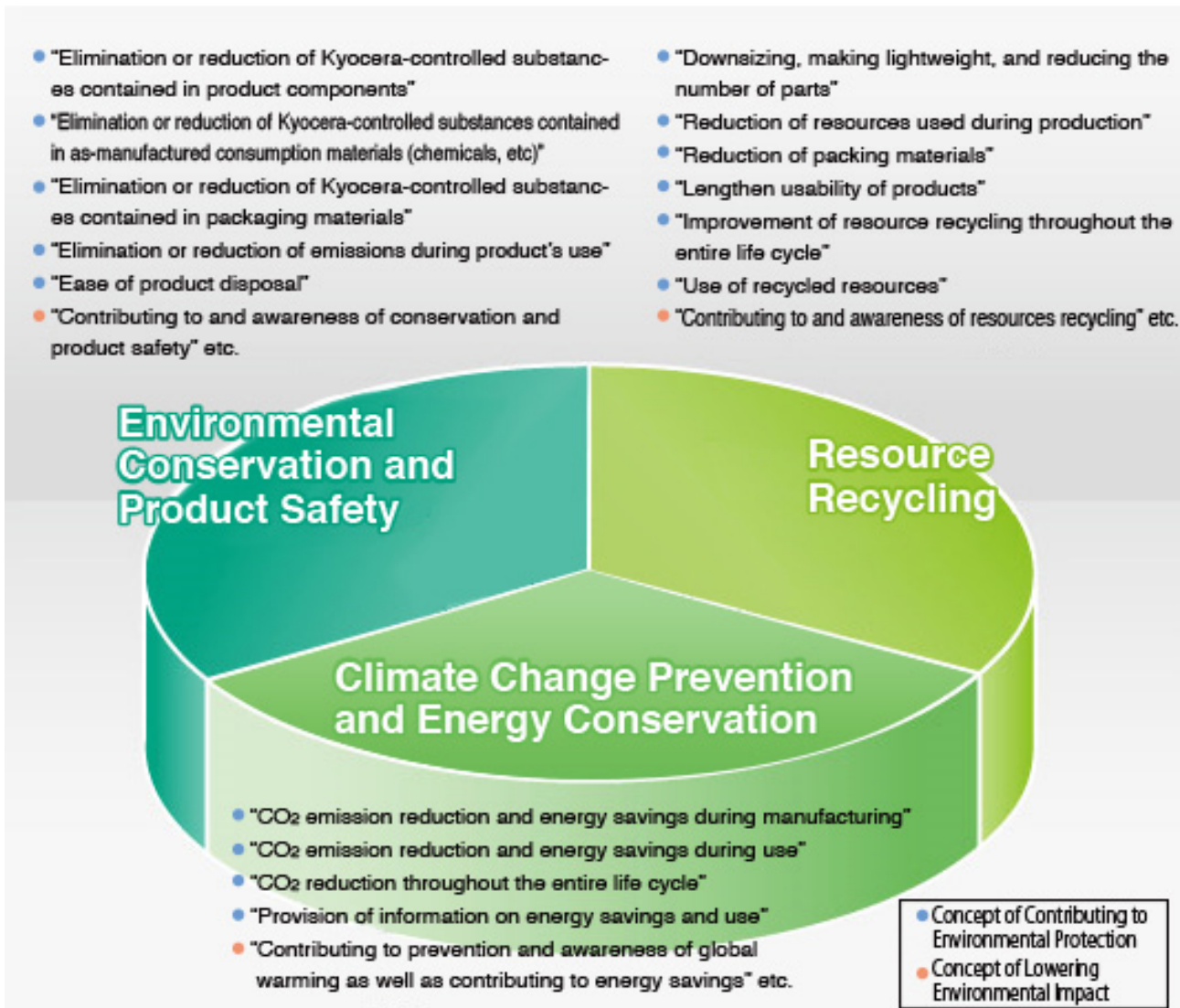

Concept of environmental consciousness

Environmentally Conscious Designs for Printers and Multi-Functional Products (MFPs)

Kyocera Document Solutions Inc. is working on environmentally conscious designs for all of its products, including long service life designs that reduce parts replacement and disposal, 3R designs that consider "reduce," "reuse," and "recycle," and low power-consuming designs that reduce greenhouse gas emissions.

In the design stage, designs are developed based on the Environmentally Conscious Design Standard from the initial development stage of new products through each of the subsequent development steps. The Environmentally Conscious Design Check Sheet is then used to make sure designs are environmentally conscious during product development.

Environmentally Conscious Designs for Printers and Multi-Functional Products (MFPs)

Kyocera Document Solutions Inc. is working on environmentally conscious designs for all of its products, including long service life designs that reduce parts replacement and disposal, 3R designs that consider “reduce,” “reuse,” and “recycle,” and low power-consuming designs that reduce greenhouse gas emissions.

In the design stage, designs are developed based on the Environmentally Conscious Design Standard from the initial development stage of new products through each of the subsequent development steps. The Environmentally Conscious Design Check Sheet is then used to make sure designs are environmentally conscious during product development.

Kyocera Document Solutions also conducts a life cycle assessment (LCA), which digitalizes the resources, energy, and waste used or discharged for products or services during the stages from the acquisition of resources to manufacturing, transport, use, and disposal/recycling for all products to reduce the environmental burden of our products.

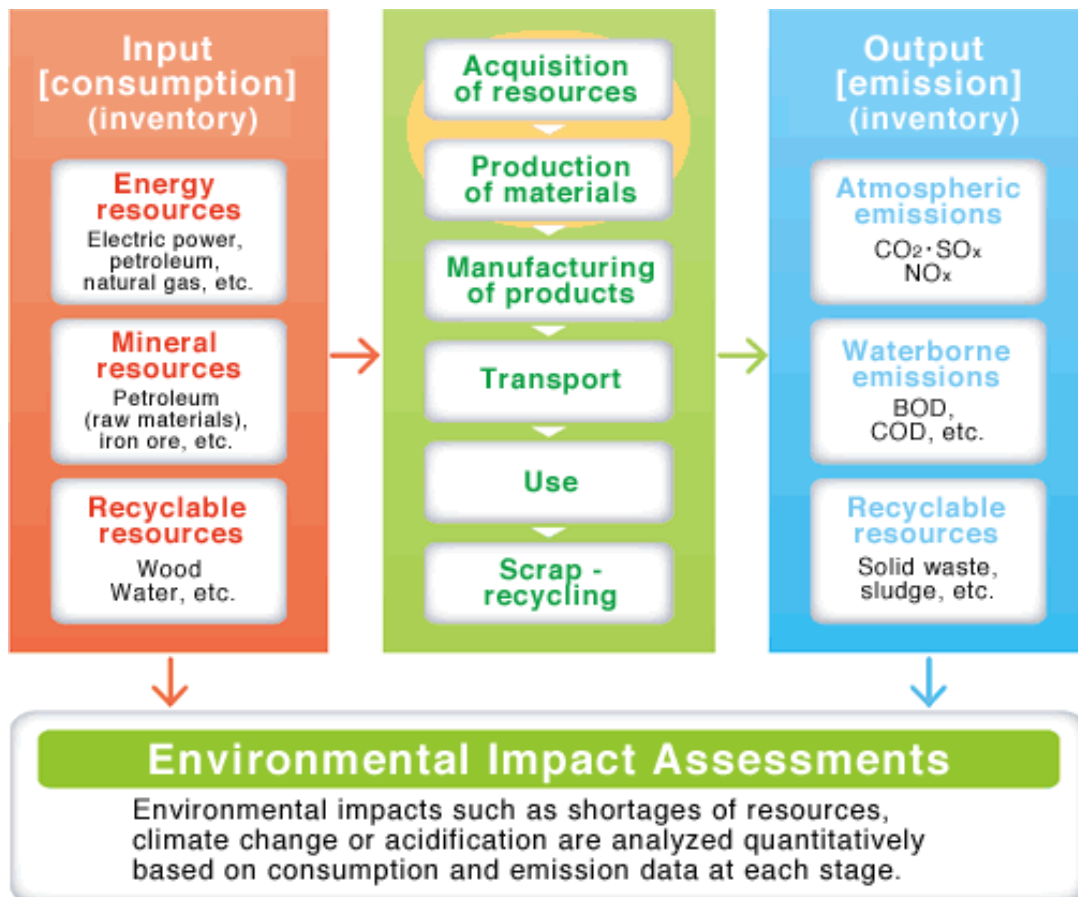

Life cycle assessments

Environmentally Friendly Products

The Kyocera Group develops environmentally friendly products including fine ceramic products, energy management systems (HEMS and BEMS), solid oxide fuel cells (SOFC), LED lighting, and solar power generation systems.

Fine Ceramic Products

Fine ceramics are representative ecological materials. Because of their excellent mechanical, electromagnetic and thermal properties, fine ceramics are used frequently in machines and equipment for industrial use in such fields as environment, energy and automobiles. This contributes to the prevention of environmental pollution, conservation of resources and the prevention of climate change.

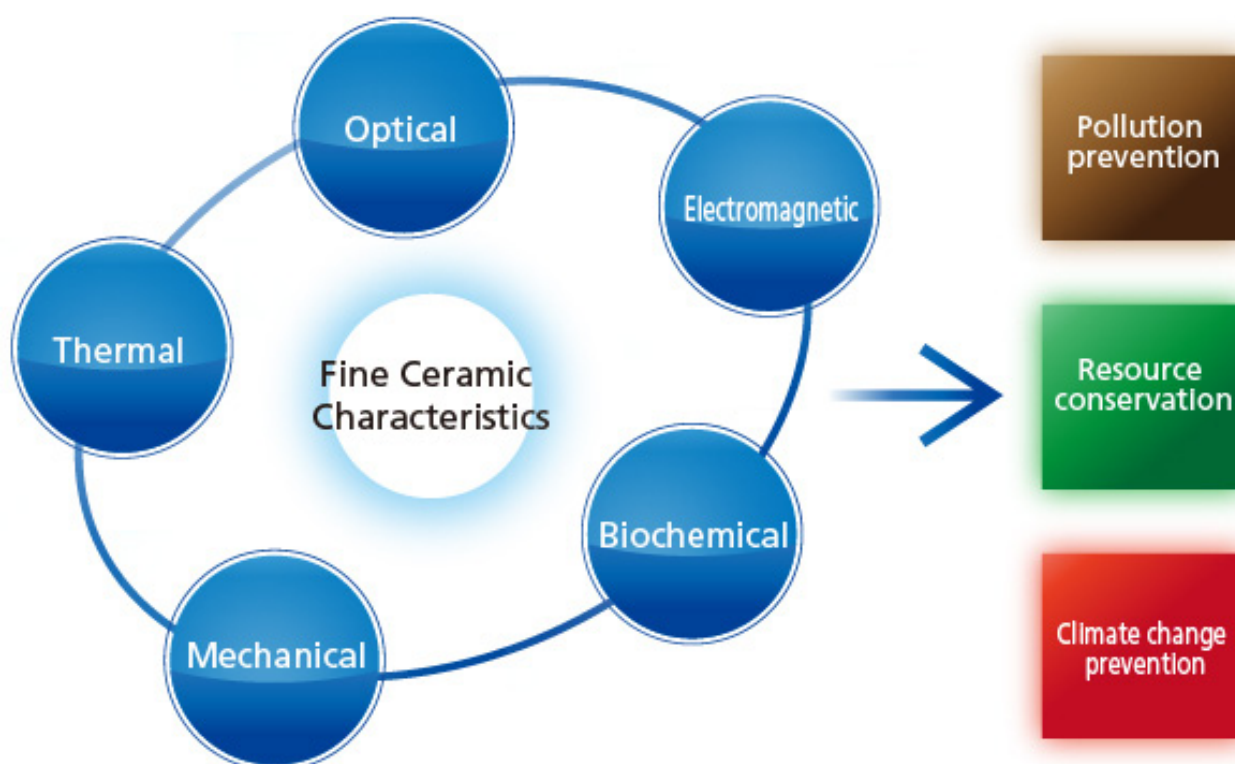

Home-Use Solid Oxide Fuel Cell (SOFC) Cell Stack

A residential-use fuel cell has two parts — a power generation unit and a water heating unit that uses exhaust heat from the power generation unit. The fuel cell has high energy efficiency, and produces only extremely small amounts of the greenhouse gases CO₂, nitrous oxides, sulfur oxides or other byproducts. Use of the fuel cell as an environment-friendly system is expected to increase.

Kyocera realized the world's highest level power generation efficiency* by promoting the development of cells and cell stacks, which form the core of solid oxide fuel cells (SOFC) with high power generation efficiency, and using fine ceramics, which have excellent thermal resistance and durability, as cell materials.

* Among domestic-use fuel-cell cogeneration systems (as of January 24, 2013)

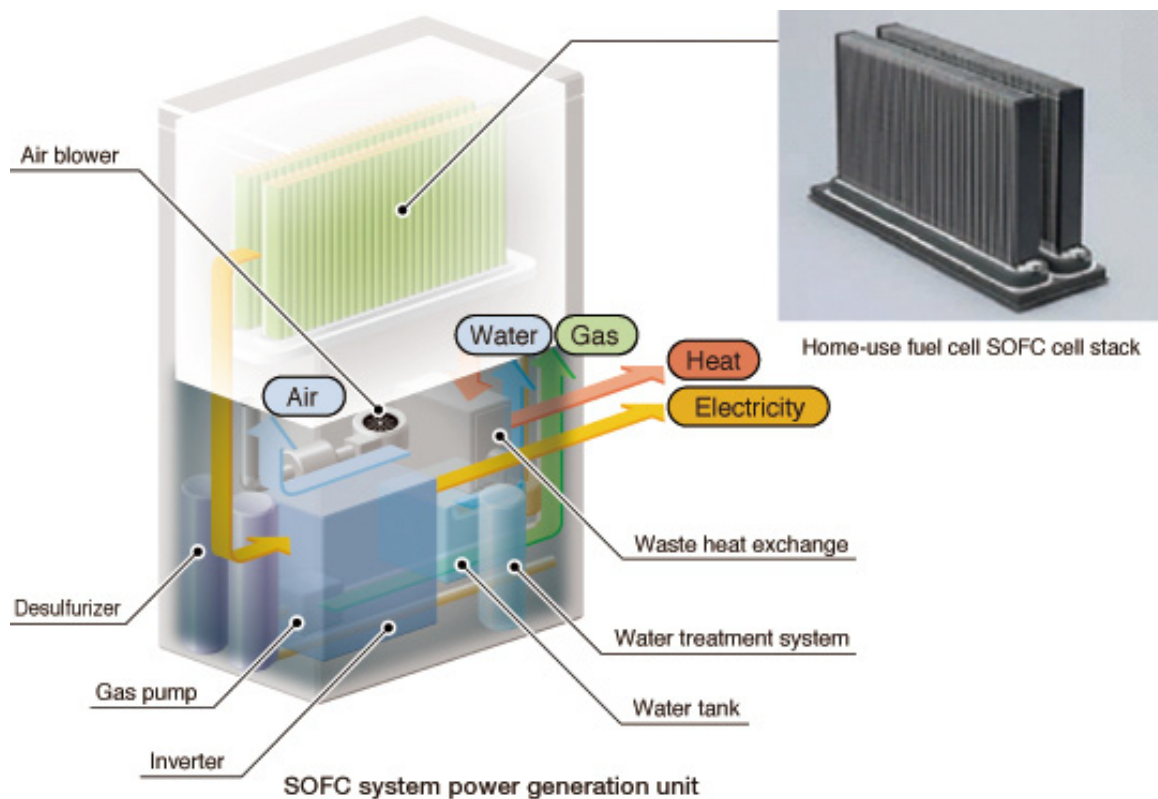

Ceramic Filters

Excellent in thermal resistance, ceramic filters are used in emission gas treatment equipment such as those at large-scale waste incineration plants which optimize efficient use of exhaust heat energy. Compared with the service temperature range (150 to 200°C) of conventional bag filters, ceramic filters are capable of collecting dust at higher temperature ranges (300 to 900°C) to realize improved energy efficiency during the use of waste heat and the reuse of filters by washing.

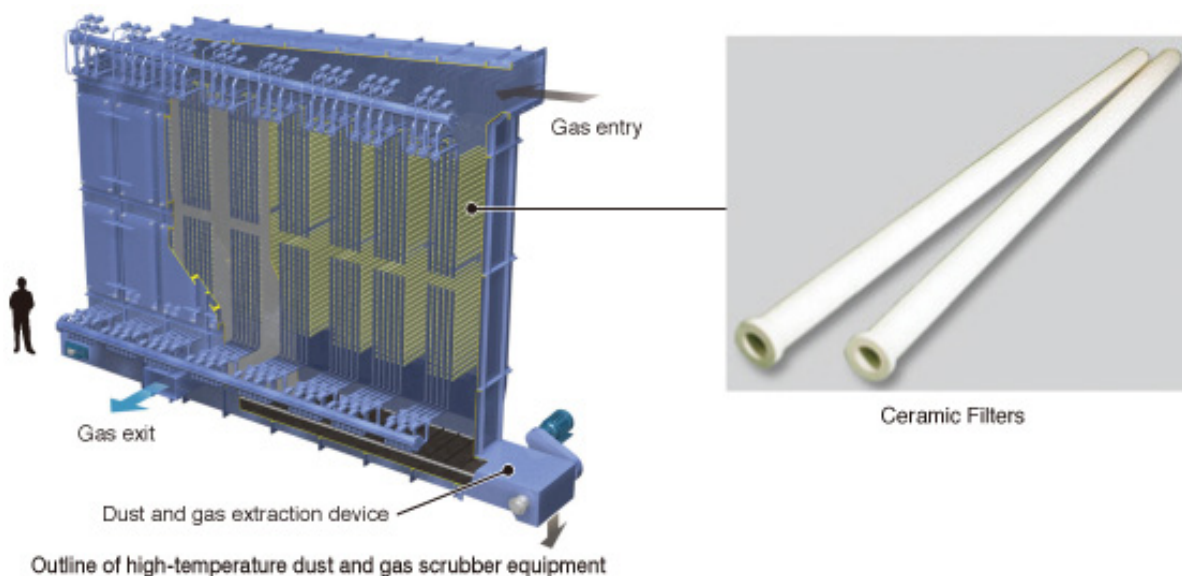

Ceramic Glow Plugs and Stacked Piezoelectric Elements

Ceramic glow plugs help start up (ignite) engines and reduce the generation of toxic substances in gas emissions. Piezoelectric stacks for fuel injectors use piezoelectric ceramics and help optimize combustion by precise control of the high-pressure injection of fuels and the volume of injection as components of fuel injectors.

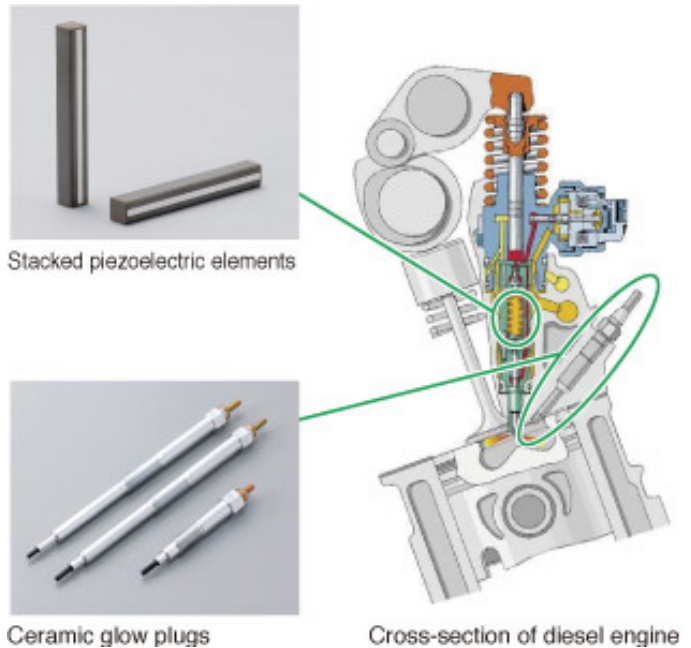

Aluminum Foundry Components

Kyocera's silicon nitride ceramic material features outstanding high-temperature strength, heat and thermal shock resistance as well as corrosion resistance. When used in molten aluminum smelting equipment for the production of automobile engines and aluminum wheels, silicon nitride extends the product life of components and reduces the risk of impurities entering molten metal. With such benefits, silicon nitride contributes to the reduction of waste and improves product quality.



Aluminum foundry components

LED Packages and Single-Crystal Sapphire Substrates

Since ceramic materials are capable of efficiently diffusing the heat generated by LEDs, they can maintain high longevity and reliability without compromising LED luminescence efficiency. Such features led to the realization of very bright LEDs.

Single-crystal sapphires are used as the base substrates of LEDs and the backlights of mobile phones and LCD TV sets.

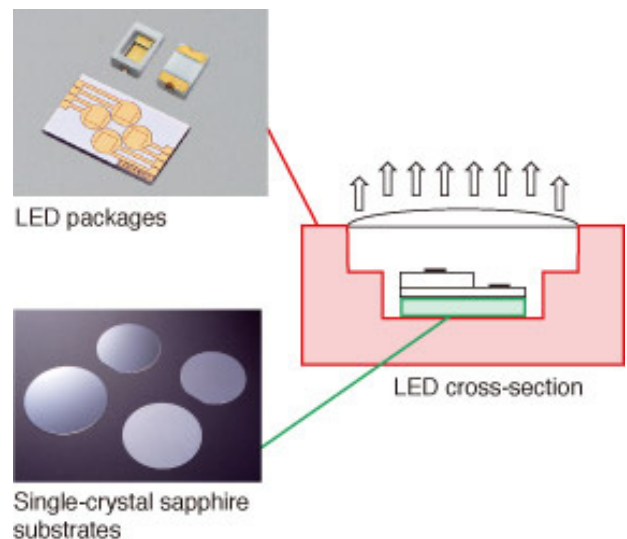

Cutting Tools

Milling Cutters

Milling cutters are used in a variety of metal cutting processes. Featuring both reductions in cutting resistance and excellence in loss resistance, milling cutters contribute to the improvement of productivity through stable processing and elongation of service life.



Milling cutter

Recycling of Used Cutting Tools and Tip Cases

Kyocera collects and recycles cutting tools and tip cases after use at users' production sites. Kyocera is actively involved in the reduction of waste and effective utilization of resources by properly recycling collected tips and tip cases for relevant applications, such as material powder and RPF (refuse plastic fuel), slag used for roadbed material, and others.

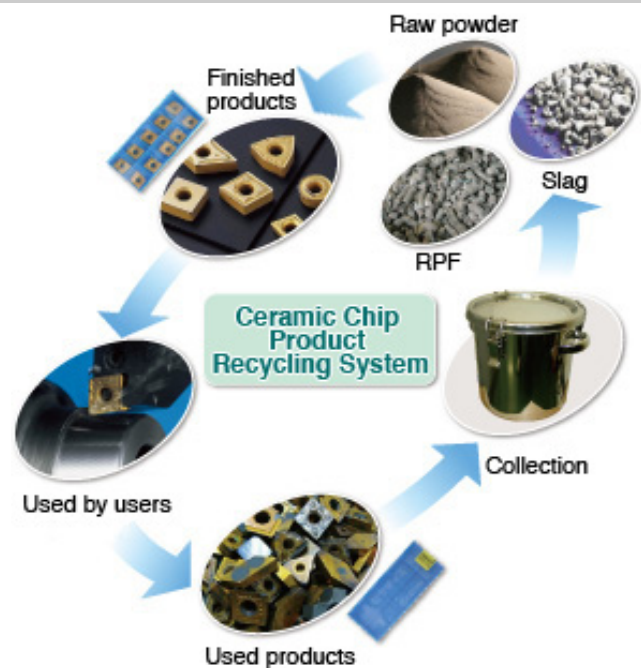

Solar Power Generating Systems

Kyocera started R&D of solar power cells in 1975 based on our belief that solar power technology would become essential for the creation of energy alternatives to petroleum and other fossil fuels in the wake of the Oil Shocks. For nearly 40 years since then, we have steadily focused on this business without being swayed by changes in social conditions, and have supplied solar energy products to markets worldwide.

At Kyocera, the cumulative power generation^{*1} produced by a solar power generation system after installation minus the amount of electricity used to manufacture the system^{*2, 3} is calculated as the “energy creation effect.” The power consumed to produce a 1kW solar power generation system is about 1,550kWh. If this system operates for 20 years (service life) to generate power, it will produce 20,640kWh. The energy creation effect per 1kW system is thus 19,090kWh.

The solar power generation systems manufactured and sold by Kyocera so far produce a total of 5,150MW, which produces an energy creation effect of 11,746GWh. Assuming these systems generate power continuously for 20 years after installation, the CO₂ reduction effect will be 38,513,000 tons^{*4}, which is equivalent to about 43.0%^{*5, 6} of annual CO₂ absorption by all forests in Japan.

Energy creation effect of the solar power generating system

$$= \text{Accumulated electricity after installation}^{*1} - \text{Used electric energy during production}^{*2,3}$$

Electric Energy Created

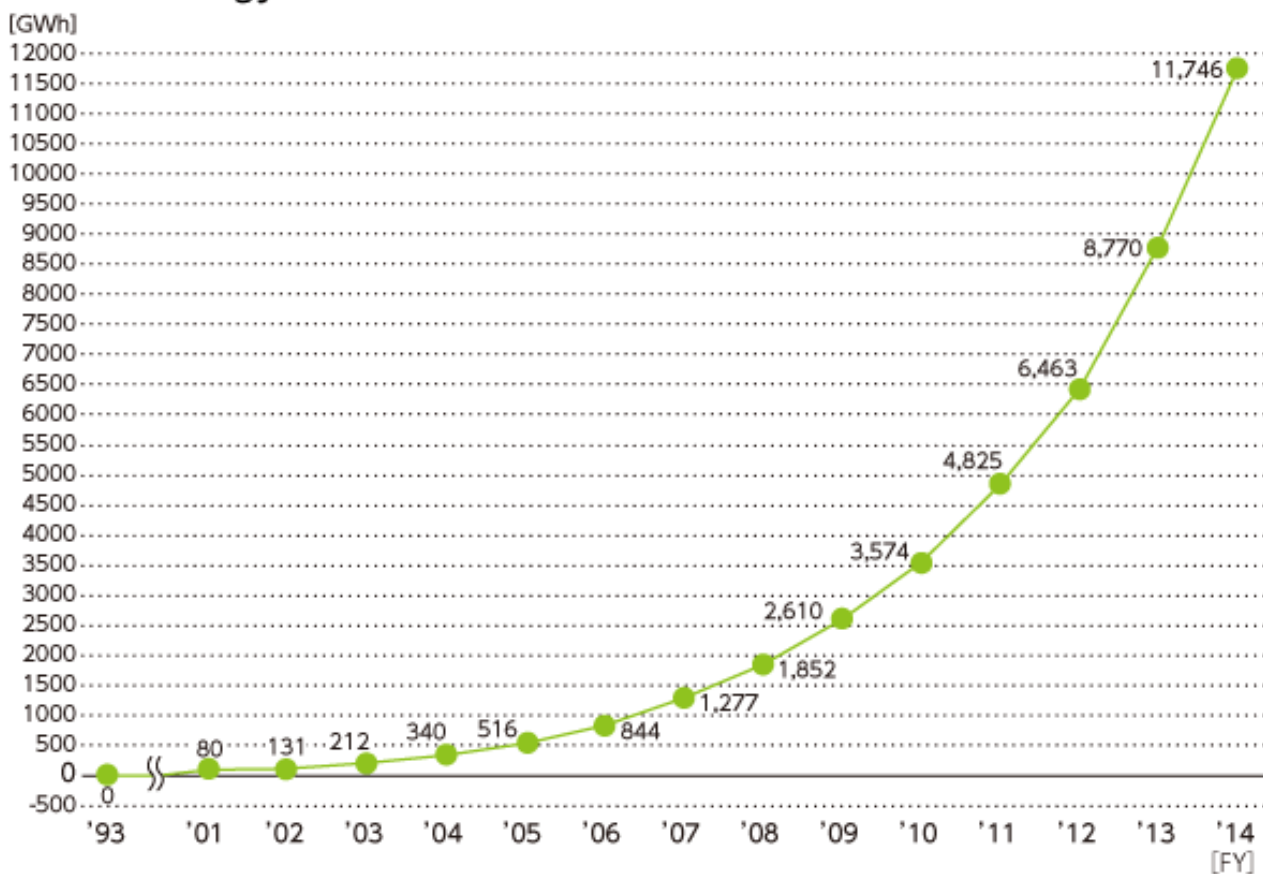

*1 Calculated from the average of expected power at 16 sites around the country in a simulation by Kyocera Corporation

*2 With energy payback of 1.1 years (annual production scale: 100MW or higher), the power consumption for production was estimated (system scale 30MW/installed on the rooftop) based on the assumption of 20 years of service life (source: NEDO Commission-based Service Result Report (Photovoltaic Power Generation Technology Research Association) “Survey and Research on Solar Power Generation Evaluation,” March 2001). We are currently revising the definition of the energy creation effect as a result of the revision of the source.

*3 The estimated amount of electricity used during production for solar power generation systems that were shipped from 1992 to 2010 was recorded in the year when the products began to generate electricity (Example: The amount of produced electricity in 1992 was recorded in 1993).

*4 Calculated at 360g-CO₂ per kWh.

*5 The CO₂ sink by 1ha (10,000m²) of forest is 3.57 tons-CO₂ (Source: Solar Power Generation Introduction Guidebook < Main > 2000 Revised Edition NEDO).

*6 Calculated assuming that the forest area in Japan is 250,800km² (Source: Forestry Agency "Present State of Forest Resources (as of March 31, 2012)").

■ Multicrystalline silicon solar cell that achieves a conversion efficiency of 18.6%

In 1982, Kyocera was the first company in the world to succeed in full-scale mass production of multicrystalline silicon solar cells. Since then, we have accumulated high-efficiency technology and evolved our production technology through the development of solar power systems over many years. In February 2014, Kyocera attained a conversion efficiency of 18.6% as a result of improvements in crystal quality and electrode manufacturing processes. We will take advantage of our strength in mass producing solar cells starting from the cell manufacturing process and continue to provide solar cells with high efficiency and quality by improving our production technology, thereby assisting in the spread of solar power generating systems and contributing to the betterment of the global environment.

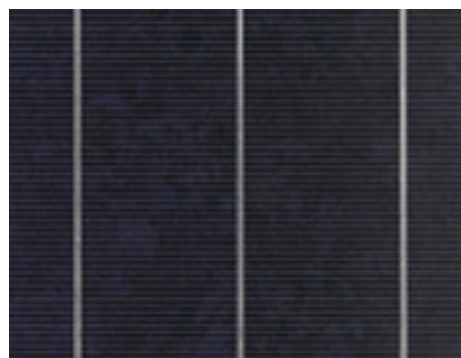

Multicrystalline silicon solar power cell

■ Japan's largest solar power generation plant*, Kagoshima Nanatsujima Mega Solar Power Plant, starts full operation

The 70 MW Kagoshima Nanatsujima Mega Solar Power Plant, Japan's largest, was completed and started operation in November 2013. The Plant is composed of approximately 290,000 Kyocera solar modules installed over an area of land about 1,270,000m² (equivalent to about 27 baseball stadiums) which is owned by IHI. Annual power generation is about 79,000MWh, equivalent to the needs of 22,000 ordinary households a year. The plant is expected to reduce CO₂ by about 25,000 tons. Kyocera intends to help revitalize local communities through the realization of environmental business by means of solar power generation and contribute to the betterment of the global environment and local and global society by promoting the diffusion of renewable energies.



Kagoshima Nanatsujima Mega Solar Power Plant

* As of November 4, 2013 (based on research by Kyocera)

Energy Management Systems

Kyocera developed its own Home Energy Management System (HEMS) designed to manage energy efficiently using our strengths in solid oxide fuel cell (SOFC) “energy creation technology” and “communication technology.” By linking solar power, SOFCs, and storage batteries with the utility power grid, the system conducts optimal power control. It also “visualizes” the status of power consumption on a PC or smartphone to realize more efficient power consumption.

Our services for convenience stores and other commercial facilities are known as Building Energy Management Systems (BEMS). These use various sensors to collect and analyze power consumption data and conduct efficient operational management of equipment such as solar power generating systems, battery systems, LED lighting, air-conditioning, and large refrigerators.

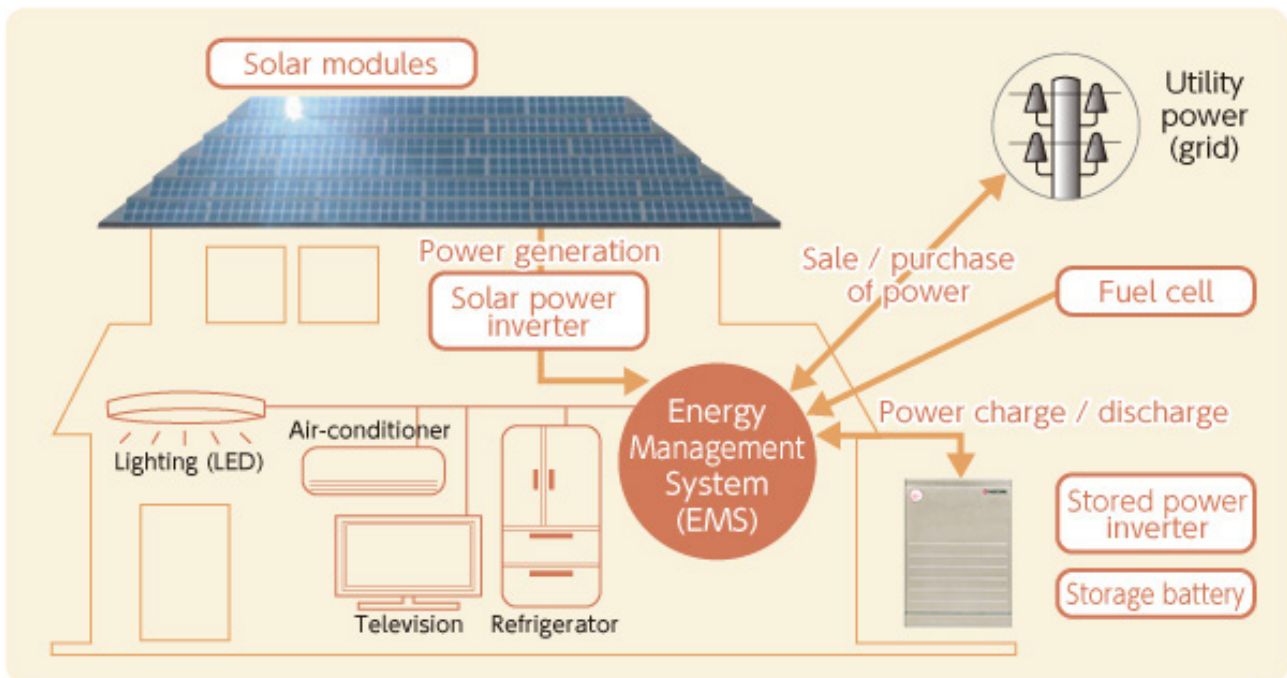

Energy Management System

Printing Devices

a-Si Photoreceptor Drum

High-durability amorphous silicon (a-Si) photoreceptor drums are often used as a core component of laser printers and multi-functional products (MFPs) to help elongate the service life of equipment, reduce maintenance costs, and reduce waste.



High-durability a-Si photoreceptor drum

LED Lighting

Kyocera's LED lighting uses white LED lamps as its light source. They produce light close to that of sunlight, thereby creating gentle and comfortable environments. They are bright enough for use in offices, conference rooms, convenience stores and other commercial shops, and are easily affixed to the ceiling with a slim and simple design. Color tones that can be changed according to use, and low power consumption compared to fluorescent lamps are just a few of the benefits of Kyocera's LED lighting. As our LED light packages use ceramic materials, they have an expected product life of approximately 100,000 hours. That is about 2.5 times longer than conventional LED resin packages.



Convenience store using Kyocera's LED lighting

Connectors for LED Lamps and LED Backlights

These connectors are made very low at only 1.4mm in height so they do not disturb light distribution. Because of this compact design, Kyocera connectors help realize LED installation in compact and thin devices.

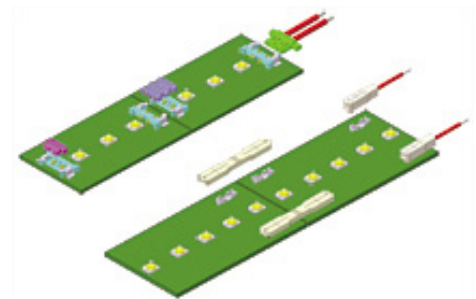

Schematic illustration of substrates fitted with LEDs and connectors

Clear Encapsulation Material for LED Devices

LEDs are composed of elements made of a gallium composite or other material sealed by transparent resin. The characteristics of the sealing resin affect longevity. Kyocera Chemical Corporation supplies transparent sealing materials capable of maintaining high transparency for a long time.

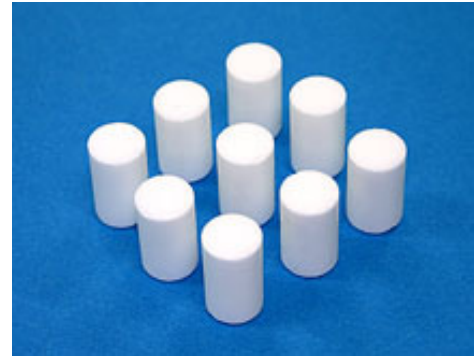

Clear encapsulation material for LED devices

Organic Materials

Halogen-Free Materials

Halogenated elements, such as chlorine, bromine, and others, may produce harmful substances such as dioxin when burned. Their use is controlled according to regulations for chemical substances all over the world, with Europe as a leader. Kyocera Chemical Corp. has developed a wide variety of halogen-free* materials that conform to such legal regulations and contribute to a reduction in the environmental burden caused by the use of chemical substances.



Molding compounds for semiconductor encapsulation

* Based on the standard values of the Japan Electronics Packaging and Circuits Association (JPCA).

Low-VOC Materials

VOC (volatile organic compounds) is the generic name for organic compounds which are highly volatile and turn into vapor in the atmosphere, including toluene, styrene, and many other substances. VOC is considered to be one of the causes of suspended particle matters and photochemical oxidant, which are suspected to affect human health. In the insulation varnish field, where varnish is used for insulation of motors, Kyocera Chemical Corp. has developed and markets styrene-free varnishes that reduce VOC generation to 1/50 or less that of conventional products, as well as greatly reduce odor.



Insulation varnish

Promotion of Green Procurement

Aware of the importance of making efforts in the entire supply chain including Kyocera as well as our suppliers and business associates in order to tackle worsening global environment issues, Kyocera formulated the Kyocera Green Procurement Guideline in 1998 and has promoted green procurement since then. In FY2014, we revised this Guideline and divided it into two guidelines, the Kyocera Guideline on Environmentally Hazardous Substances, which established the standards for product specifications in promoting green procurement; and the Kyocera Guideline on Environmental Protection Activities, which describes the guiding principles of Kyocera's idea of environmental protection activities. With this revision, we have reinforced our ties with our business partners.

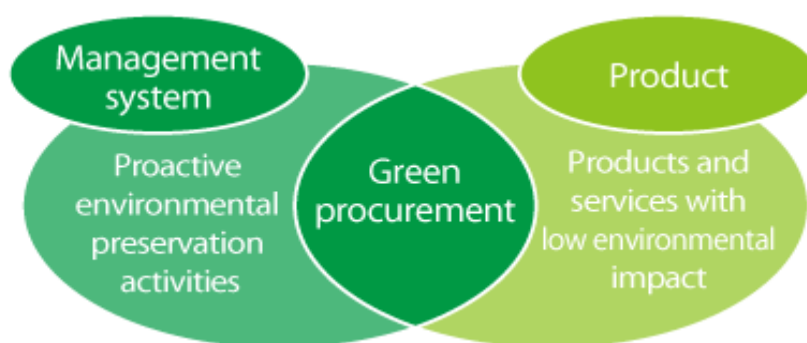

Conforming to Environmental Product Regulations

Today, the creation of products that are more friendly to the global environment is being demanded while regulations on the restriction of chemical substance management and use (RoHS Directives^{*1}, REACH^{*2}, etc.) are being reinforced from the perspective of preventing impacts on humans and environmental pollution. In response to these moves, Kyocera regularly holds Product Environmental Quality Meetings to develop company-wide response measures and share information on environment-related laws and regulations. In addition, each production department responds to environmental regulations by obtaining information on the chemical substances contained in each purchased item and conducting thorough management of chemical substances in every process.

*1 Restrictions on the use of specified substances contained in electric and electronic equipment

*2 Regulations on the registration, assessment, permission and control of chemical substances

Green Factories: Environmental Consciousness at Plants and Offices

Energy Conservation and Prevention of Climate Change

Increased energy consumption has an impact on the environment, including negative effects such as climate change. We share the task of using limited energy resources more effectively, including energy use in industrial activities.

The Kyocera Group works on measures for the prevention of climate change in various ways, including the setting of targets for greenhouse gases and energy reduction, and the implementation of energy-saving measures in business activities.

Energy Saving and Reduction of Greenhouse Gas Emissions

In FY2014, the Kyocera Group successfully achieved a 3.1% reduction in the greenhouse gas emissions basic unit and 10.2% reduction in the total energy consumption basic unit compared with FY2013 due to various efforts including the improved operation of deodorizers and effective use of waste heat despite an increase in energy consumption due to the acquisition of Kyocera Circuit Solutions, Inc. (KCS).

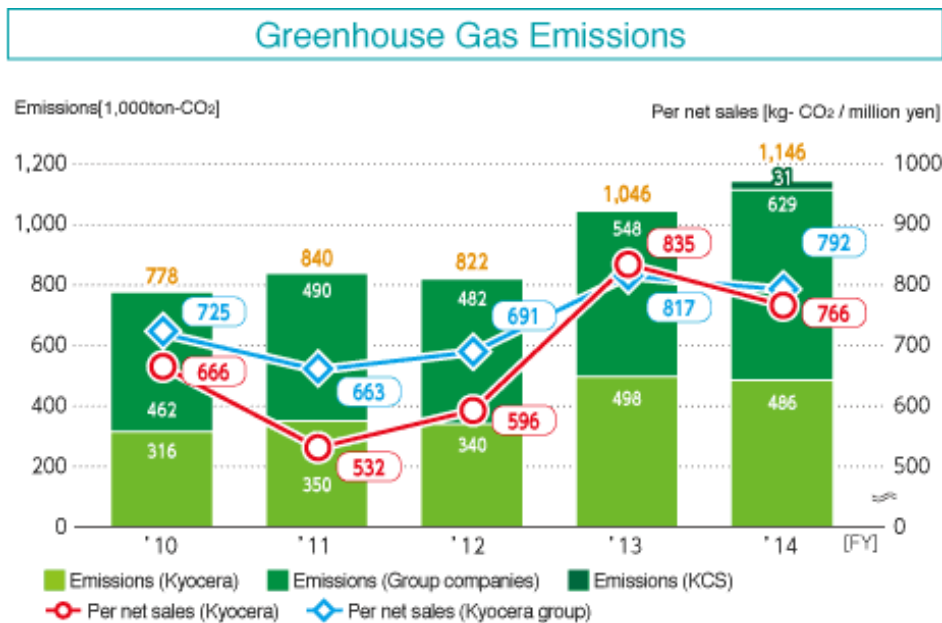

Total Amount of Energy

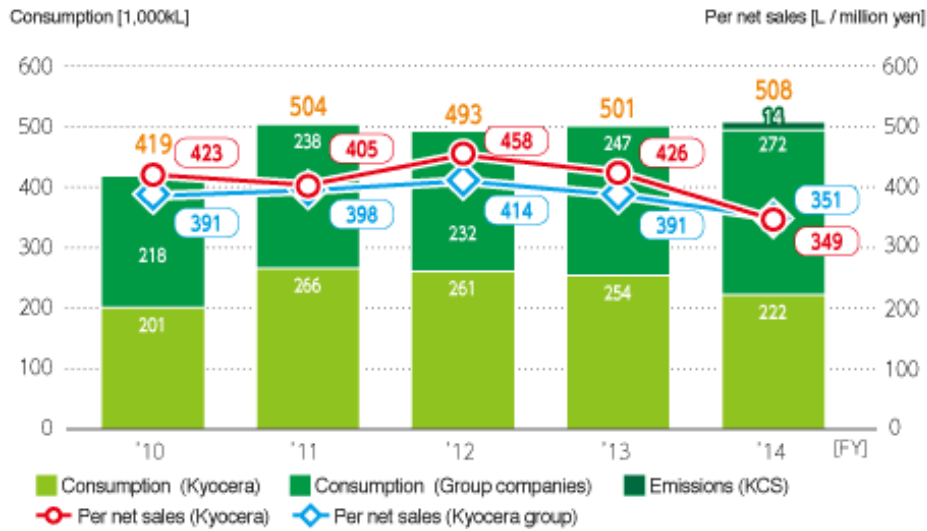

- From FY2009, emission coefficients are calculated based on the Act on Promotion of Global Warming Countermeasures.
- Greenhouse gas means CO₂, CH₄, N₂O, PFC, HFC, and SF₆.
- Figures for overseas facilities are calculated using the emission coefficients of electricity for each country in IEA CO₂ EMISSIONS FROM FUEL COMBUSTION Highlights (2012 Edition).
- In 2013, greenhouse gas emissions and total energy consumption went up as a result of a business acquisition (KCS). (Data for six months from October 2013 to March 2014)

Efforts to Reduce CO₂ Emissions Associated with Freight Transport

Energy-saving actions taken by the Kyocera Group include the revision of transport routes to reduce distances and the integration of cargo transport to reduce the frequency of transport. However, the CO₂ emission basic unit related to cargo transport increased by 15.2% over FY2013 due to the increased production of solar modules.

CO₂ Emission Associated with Freight Transport

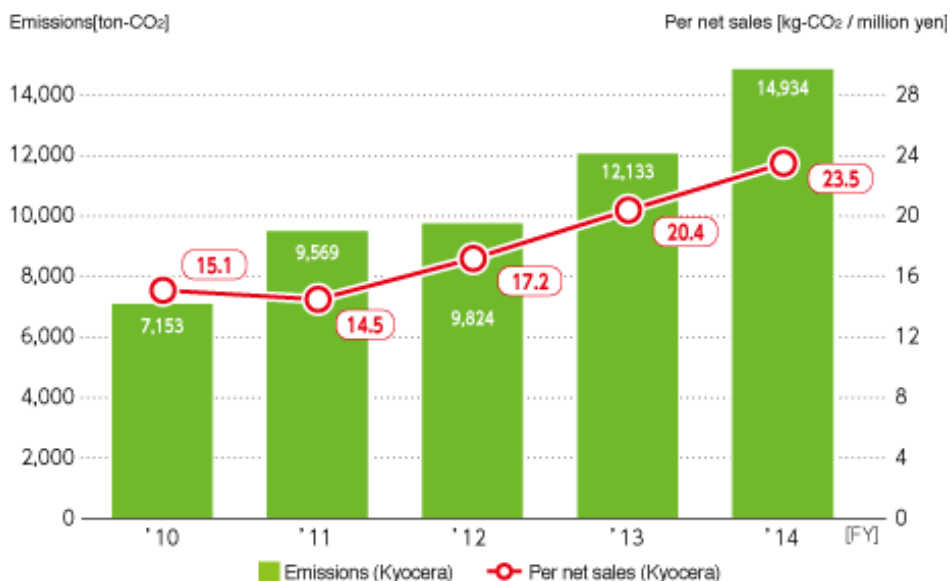

■ Growing “Green Curtains”

The Kyocera Group promotes “Green Curtains” which block strong summer sunshine and suppress rises in indoor temperature by covering windows and outer walls with bitter melon, sponge melon, Japanese morning glory and other climbing plants.

In FY2014, Green Curtains were installed at 30 plants and offices in Japan and four sites outside Japan. The total length of all Green Curtains measured 982m with a total area of 4,191m² (equal to about 16.1 tennis courts), which translates to a successful reduction of about 15,000 kg of CO₂ annually. We plan to install Green Curtains at 34 sites in FY2015.



Green Curtains
(Fukushima Tanagura Plant)

■ One Approach

Installation of Solar Power Generating Systems

The Kyocera Group has introduced a solar power generating system at facilities at home and abroad, such as the Kyocera Head Office Building and Kyocera International Inc., Kyocera’s holding company in North America.

We installed 5.6MW of solar power generating systems subject to application of the renewable energy feed-in tariff program at a total of 9 sites in Japan, including the Gamo Plant and Yohkaichi Plant in Shiga Prefecture in FY2014. Solar power generating systems installed inside and outside of Japan at Kyocera Group sites now have an output exceeding 8.3MW. We will continue to actively introduce solar power generating systems at more Group sites to expedite reductions in CO₂ emission in business activities.

In Japan



■ Hokkaido Kitami Plant (115 kW) (introduced in FY2011)



■ Fukushima Tanagura Plant (230kW) (introduced in FY2011 and expanded in FY2012)



■ Chiba Sakura Plant (493 kW) (introduced in FY1985 and expanded in FY2014)



■ Nagano Okaya Plant (173 kW) (introduced in FY2011 and expanded in FY2014)



■ Mie Ise Plant (80 kW) (introduced in FY2005)



■ Shiga Gamo Plant (491 kW) (introduced in FY2011 and expanded in FY2014)



■ Shiga Yokaichi Plant (1,137 kW) (introduced in FY2006, expanded in FY2011, FY2012, FY2013, FY2014)



■ Shiga Yasu Plant (590 kW) (introduced in FY2011 and expanded in FY2014)



■ Kagoshima Sendai Plant (649kW) (introduced in FY2011 and expanded in FY2014)



■ Kagoshima Kokubu Plant (1,100 kW) (introduced in FY2006 and expanded in FY2014)



■ Kagoshima Hayato Plant (40 kW) (introduced in FY2006)



■ Head Office (214 kW) (introduced in FY1999)



■ Yokohama Office (58 kW) (introduced in FY2012)



■ Kyocera Document Solutions Inc. Head Office (12 kW) (introduced in FY2008)



■ Kyocera Document Solutions Inc.'s Tamaki Plant (50 kW) (introduced in FY2011)



■ Kyocera Document Solutions Inc.'s Hidakata Plant (60 kW) (introduced in FY2006)



■ Kyocera Connector Products Corp. Head Office (130 kW) (introduced in FY2012)



■ Kyoto Ayabe Plant, Kyocera SLC Technologies Corporation (500 kW) (installed in FY2014)



■ Koriyama Plant, Kyocera Chemical Corporation (1,500 kW) (installed in FY2014)

Overseas



■ Kyocera Document Solutions Espana S. A. (Spain) (36 kW) (introduced in FY2008)



■ Kyocera International, Inc. (America) (279 kW) (introduced in FY2006)



■ Kyocera Document Solutions Deutschland GmbH. (Germany) (15.6 kW) (introduced in FY2008)



■ Shanghai Kyocera Electronics Co., Ltd. (China) (155 kW) (introduced in FY2010 and expanded in FY2013)



■ Kyocera (Tianjin) Solar Energy Co., Ltd. (China) (93 kW) (introduced in FY2011)



■ Kyocera Solar Europe s.r.o. (Czech Republic) (8 kW) (introduced in FY2006)



■ Kyocera Mexicana, S.A. de C.V. (Mexico) (100 kW) (introduced in FY2011)

Energy Saving by Improved Operation of Deodorization Units

Deodorization units are used in manufacturing processes at the Kagoshima Kokubu Plant, with LNG used for fuel. In FY2014, we made various improvements to the deodorization units, including a revision of the operating procedure, the consolidation of units and optimization of the set combustion temperature of catalysts to realize a reduction in CO₂ emissions.



Deodorization unit

Annual CO₂ emission reduction : 650 tons-CO₂

Reduction in CO₂ Emissions by use of Waste Heat

Freezers and boilers operate at the Kagoshima Sendai Plant to control the temperature and humidity of clean rooms. We newly installed heat exchangers to make effective use of the waste heat from turbo freezers and reduce the operation of boilers and cooling towers, thereby reducing CO₂ emissions.

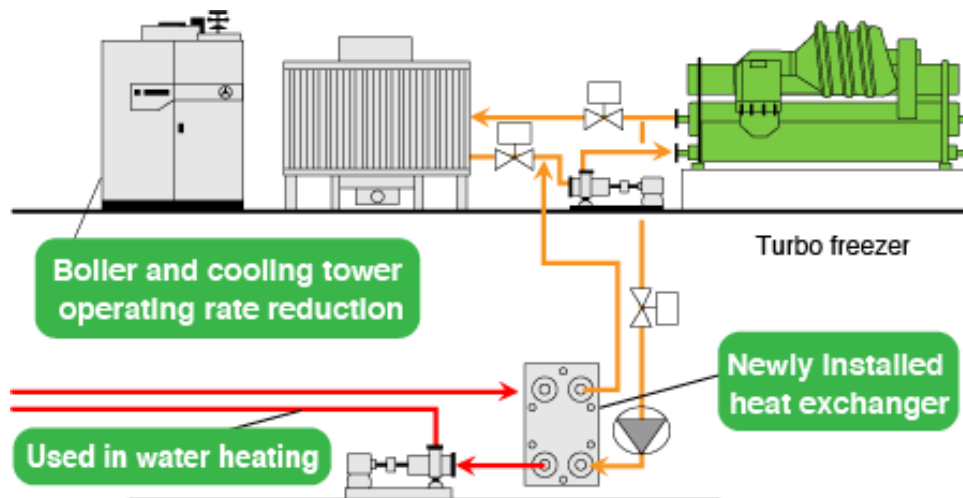

Annual CO₂ emission reduction : 440 tons-CO₂

Reduction in CO₂ Emissions by Switching to Energy-Saving Equipment

Vacuum pumps are used in manufacturing processes at the Kagoshima Sendai Plant. A large amount of electric power is consumed by those pumps. The ones that could be replaced were switched to small power-saving blowers to reduce CO₂ emissions in FY2014.

Annual CO₂ emission reduction : 260 tons-CO₂



Vacuum pump

Reduction in CO₂ Emission by Renewing Boiler Equipment

The Shiga Yasu Plant operates boilers fueled by kerosene and LNG to supply steam, mainly for use with air-conditioners. In FY2014, we switched from kerosene-fueled boilers to LNG-fueled boilers and revised the operating procedures, thereby reducing CO₂ emissions.

Annual CO₂ emission reduction : 120 tons-CO₂



Newly installed boilers

Effective Use of Water Resources

The Kyocera Group uses a large amount of water for cleaning and cooling production equipment and other purposes. We have set specific reduction targets and have developed activities to use limited water resources effectively and contribute to the protection of the global environment. In FY2014, water consumption increased as a result of the business takeover of Kyocera Circuit Solutions, Inc. However, the water consumption basic unit remained the same as that in FY2013 because of the positive effects of improvements in production processes and the introduction of recycling equipment.

Water Consumption

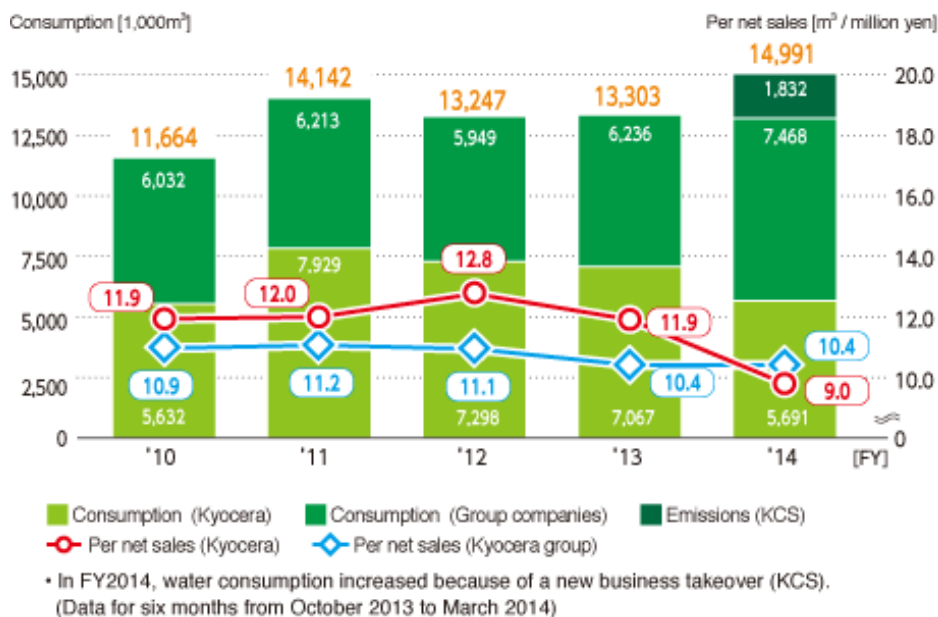

One Approach

Reduction in water consumption by reuse of super pure water

Kyocera Crystal Device (Thailand) Co., Ltd. and Kyocera Crystal Device Philippines, Inc. treat water before discharging it. In FY2014, recycling equipment was installed to reuse treated wastewater as industrial water, thereby reducing water consumption.

Annual water consumption reduction : 22,730m³



Wastewater recycling equipment

Waste Reduction and Recycling Measures

Working towards a recycling-based society, the Kyocera Group has set basic policies for waste reduction since FY1992, and expanded activities aiming to minimize industrial waste.

Basic Policies for Waste Reduction

1. Eliminate use of non-recyclable materials
2. Minimize waste generated by business activities
3. Recycle waste once it is generated
4. Process non-recyclable waste into harmless materials

Reduction in Waste Discharge

In FY2014, the Kyocera Group achieved a 14.1% reduction in the industrial waste emission basic unit compared with the previous year as a result of various actions including the revision of the treatment method for wastewater generated during manufacturing processes and the introduction of effluent treatment equipment.

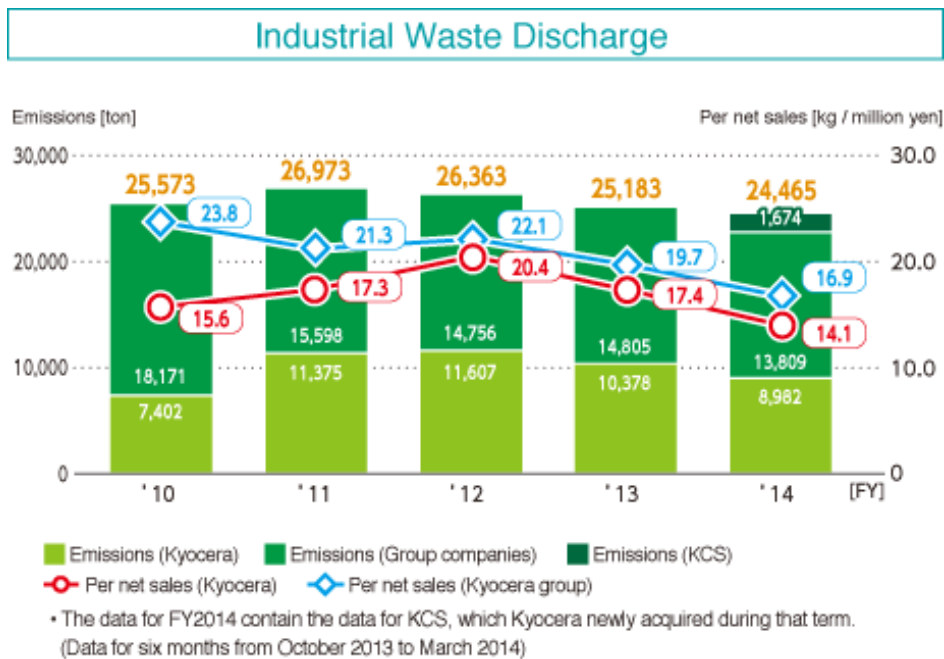

Promoting Zero Emissions

The Kyocera Group (Japan) promotes the zero emission movement. Except for some waste whose disposal method is designated by local governments, it is our rule that the amount of waste to be disposed of at final landfill sites (including the landfill volume of waste emitted by intermediate treatment contractors) is less than 0.5% of total waste.

All Kyocera Group companies in Japan have achieved zero emissions and will continue their efforts.

One Approach

Reduction in Industrial Waste by Changing an Effluent Treatment Method

Cutting effluent generated in manufacturing processes by cutting tools at the Sendai Plant in Kagoshima contains a rare metal, tungsten. The procedure for treatment of the cutting effluent was revised in FY2014 to recover the tungsten from the effluent. This improvement now allows the plant to sell sludge and has also reduced the amount of industrial waste to be disposed of.



Cutting effluent treatment equipment



Sludge containing tungsten

Annual waste emission reduction : 660 tons

Reduction in Industrial Waste by Introducing Effluent Treatment Equipment

The Shiga Gamo Plant previously hired an external contractor to dispose of cutting effluent with a high content of organic substances generated from ceramic processing. In FY2014, the plant installed a new effluent treatment system capable of decomposing the cutting effluent with aerobic organisms, which allowed them to dispose of the effluent internally. The new system has reduced industrial waste.

Annual waste emission reduction : 240 tons



Aeration tank for treatment of cutting effluent (decomposition of organic matters with aerobic organisms)

Chemical Substances Management

Some chemical substances cause environmental pollution and can affect human health and the ecosystem as a result of long-term accumulation.

The Kyocera Group sets a voluntary control standard and takes initiative in carrying out environmental load reduction activities. In addition, the Kyocera Group (Japan) carries out thorough control of emissions and the transferred amount of Class I Designated Chemical Substances as prescribed by PRTR Law.

Management and Disposal of PCB Waste

The Kyocera Group (Japan) strictly controls and manages PCB (polychlorinated biphenyl) waste at specified locations with control sheets prepared in accordance with relevant laws. Kyocera has already become an early registrant for disposal of these wastes with the Japan Environmental Safety Corporation and will dispose of them accordingly.



Transporting operations for outsourced disposal (Kagoshima Sendai Plant)

One Approach

Reduction in Environmental Burden by Introducing Effluent Treatment Plants

Kyocera SLC Technologies Corporation's Kyoto Ayabe Plant in Kyoto (Japan) and Kyocera Vietnam Company Limited newly installed effluent treatment equipment in conjunction with the construction of new plants in FY2014 as part of efforts to reduce their environmental burdens.

They also analyze water quality at each point where effluent is generated in the production process, and water judged to be less dirty is reused in the production process via a recycling system attached to the production equipment. This operation reduces the amount of effluent as well as the amounts of chemicals required for effluent treatment.



Effluent treatment equipment newly installed at Kyocera SLC Technologies Corporation's Kyoto Ayabe Plant

Green Communication: Transparency with Local Communities Regarding Environmental Matters

Support of Environmental Education for Children

Kyocera Group “Eco-Lessons”

The Kyocera Group has conducted Eco-Lessons, a locally rooted social contribution activity, since FY2003, to help children, the next-generation of leaders, better understand environmental problems and energy, and grow with an earth-loving heart in school education. Kyocera started Eco-Lessons in China too in FY2010 based on knowhow accumulated in Japan.

In FY2014, the Kyocera Group provided lessons to 13,460 children at 218 elementary schools in areas around 26 Group sites (13 prefectures) in Japan. In China, Kyocera provided lessons to 830 children at elementary schools in two cities. The total number of children who have taken Eco-Lessons since FY2003 has reached 80,693. We believe it is important to steadily continue awareness activities and endeavor to encourage children to feel for the Earth.



Children enthusiastically taking a lesson (Japan)



Hands-on lesson with solar cell kits (China)

Supporting “Kids’ ISO 14000 Program” for Environmental Education

Kyocera Document Solutions Inc.(KDC) is an active corporate participant in the Kids’ ISO 14000 Program, an international environmental education initiative for children. Since 2005, KDC’s in-house instructors have taught classes at local schools, encouraging children to assume leadership roles in their families and communities to promote energy savings and waste reduction. Last year, a total of eight classes were held in primary schools in Mie Prefecture of Japan with a total of 170 pupils.



Session of the Kids’ ISO 14000 Program

Activities Related to the Conservation of Biodiversity

Human society consists of various blessings from nature. On the other hand, forests equivalent to one fifth of Japan's land area are lost from the world every year. It is also said that the effect of human activities over the last several hundreds of years has caused the extinction rate of species to be accelerated by 1,000 times. In these ways, circumstances surrounding biodiversity have become extremely serious.

In regards to the Kyocera Group's business activities, while we are benefitting from the ecological system in the form of raw materials, its output has no small effect on biodiversity.

The Kyocera Group establishes working policies relating to the conservation of biodiversity on activities such as the reduction of destructive effects on the natural environment and on the ecological system, active promotion of greenification at Group facilities, and participation in and support of social contribution activities.

Promotion of Kyocera's Forestation Activities

The Kyocera Group works on the prevention of climate change and the conservation of biodiversity. The Group also conducts activities to restore rich greenery in plant compounds and local forests to improve employee awareness of environmental protection. Our employees take the initiative and participate in activities to conserve the local forest environments.

In FY2014, Kyocera conducted forestation activities in Fukushima, Nagano, Kanagawa, Shiga, Kyoto and Kagoshima prefectures (Japan), and worked with local people in thinning and bottom grass cutting.



Employees taking part in village forest conservation activities (Nagano)

Promoting Project Firefly

The Kagoshima Kokubu Plant launched Project Firefly in November 2009 in order to preserve the distinctive local biosphere around the manufacturing plant. With the cooperation of local firefly researchers, employees improved the environment around a pond in the plant premises to make it habitable. As a result, fireflies flew around the plant in May 2010, glowing brilliantly. We also endeavor to enhance the environmental awareness of employees through this project.



A firefly in the plant compound

Conservation of a Stork Habitat

Kyocera Document Solutions, Inc. has cooperated in stork protection activities in Toyooka, Hyogo since FY2011. We are proactively involved in eliminating nonnative moso bamboo — which proliferate in the vicinity of marshy areas — in order to restore forests covered with broad leaf trees — in order to restore forests covered with broad leaf trees and create an environment where storks can habitat.



Bamboo grove cutting

Environmental Protection Fun Run

In June 2013, Kyocera Crystal Device Philippines, Inc. took part in “Run 2 Plant 4 GREENIN Philippines” which was held in Cebu and coincided with Environment Month. The event was organized to promote reforestation in Naga City. Representative runners from each company completed a 5-kilometer course in the city and then planted trees.



Kyocera employees who participated in the run

Providing Employees' Families with Environmental Education and Awareness

A recent significant increase in CO₂ emissions from households, which is a suspected cause of climate change, has become a major issue. The Kyocera Group (Japan) believes that it is important for each person to seriously address global environmental issues, and has proactively promoted a program to encourage use of the Eco-Account Book at employees' homes since FY2009 in order to support environmental protection activities at home.

Participation in Environmental Events

Events Held for Environmental Awareness

Kyocera Communications, Inc. (U.S.A.) is actively involved in recycling activities to reduce its environmental burden.

The company held an Earth Expo at a Group site in San Diego in April 2014. Over 50 local companies and organizations that participated in the event introduced environmentally friendly products and services to visitors.



Earth Expo

Community Contribution Through a Cycling Event

In May 2013, Kyocera Document Solutions (U.K.) Limited took part in the “Easy Cycle Challenge,” a competition organized to encourage more people to ride bicycles, based on the idea that reduced vehicle use leads to cleaner air and safer streets. Participants competed for the greatest cycling distance during a four-week period from May to June 2013. Kyocera won first place in the category of 3 – 6 participants and finished second in the 50 – 199 category.



Kyocera employees going the distance in the bicycle challenge

Main Feedback on Sustainable Management

Award for the Promotion of Measures to Cope with Global Warming Received for Four Years in a row from the Ministry of the Environment

The Kagoshima Sendai Plant won this award for its excellent global warming prevention activities through energy saving efforts in 2013. Kyocera received the award in the “technology development and product category” for its high-output solar module in 2010. The Shiga Gamo Plant and Shiga Yohkaichi Plant received the award in the “countermeasure category” in 2011, and the Fukushima Tanagura Plant won the same award in 2012. The Kyocera Group has thus received the award for four consecutive years.



Award ceremony

Risk Management and Compliance

Reinforcement of the Risk Management System

The Kyocera Group is making Group-wide efforts to reinforce its risk management system to cope with global risks that are becoming ever more complicated. There are various risks including conventional business risks such as changes in the market environment, the occurrence of natural disasters, and soaring prices of raw materials; as well as other risks that may affect the credibility or business sustainability of the Kyocera Group, such as the impact of climate change, information leaks, and inappropriate working conditions or human rights violations in the supply chain. Each management division addresses these problems and finds solutions. If a serious incident occurs or is likely to occur, the Risk Management Division swiftly gathers information to cope with the situation. The Kyocera Group thus has an appropriate system in place to take care of risk related issues.

Business Continuity Plan (BCP) Efforts

The Kyocera Group conducts continuous measures for disaster prevention and is reinforcing efforts to ensure business continuity so that we will be able to continue the supply of products and services to customers.

In Japan, the Kyocera Group has a BCP in place for a large-scale earthquake. Important machinery and equipment is fixed in place, the procurement of repair components arranged, and means of alternative production maintained. BCP drills are conducted to help employees understand the series of actions required in the event of an earthquake, from ensuring safety to the prevention of secondary disasters and business recovery, and are taught to react smoothly. Drills have been conducted in a total of 183 divisions including all manufacturing divisions and environment divisions. Drill sessions were completed by October 2013. Drills are being conducted sequentially at Group companies in Japan.



Earthquake disaster drills
(Head Office, Kyocera Display Corporation)

BCP activities designed to cope with assumed disaster risks that match each local situation are undertaken proactively at overseas Group companies.

BCP Efforts for the Supply Chain

The Kyocera Group conducts BCP activities in concert with our business partners, including the evaluation of alternative items and the promotion of multiple purchasing sources with respect to the procurement of important raw materials and components so as to prevent the stagnation of production activities during a disaster situation. Kyocera formulated the Supply-Chain CSR Deployment Guideline to help our business partners understand our ideas about CSR. We revised the Guideline in FY2014 to add a new item on the Business Continuity Plan and have started a survey on our business partners' BCP efforts. We will continue to work with our business partners to conduct BCP activities.

Information Security Efforts

The Kyocera Group makes effective and efficient use of information assets. We have clarified the basic requirements that employees should comply with in the handling of information assets and established an information management system.

Information Security Management Policy and System

The Kyocera Group regards information on management strategies, product development, knowhow, technology, organization, and personnel as important assets of the company. To ensure sufficient protection of these information assets, we have formulated the Technical Knowhow Leak Prevention Guideline, which specifies necessary rules for the management of information assets including confidential information management, intellectual property management, physical security management, visitor management, and personnel management. In addition, the Kyocera Group has established a digital information security management policy and management regulations to ensure the thorough management of digital information.

The Kyocera Group has established a Digital Information Security Committee with the President as its chairman and is implementing various digital security measures including periodic employee education, restrictions on the external use of information equipment, and the reinforcement of e-mail security. The Audit Division and Information System Division also conduct audits and when any problem is found, endeavor to solve it while working together with the division that owns the information and the relevant management division.

One Approach

■ Restrictions on Camera-Equipped Mobile Phones in Workplaces

The Kyocera Group revised its Rules on Mobile Phones in Workplaces in January 2014 and reinforced its measures on information security related to mobile phones as part of its measures against the leaking of technical knowhow and confidential information owned by the Kyocera Group. Camera-equipped mobile phones are restricted at Kyocera production sites, and the places where photography is banned have been clarified. Employees, customers, business partners and visitors who enter Kyocera plants and offices are obliged to follow these regulations.



Labeling of places where photography is prohibited

Protection of Personal Information

The Kyocera Group regards the personal information obtained from stakeholders through business activities as important private information and strives to protect it thoroughly as a social responsibility.

Kyocera has established a basic policy on personal information, clarifies the purpose of use of personal information and contacts for relevant inquiries, and provides employees with education on the handling of personal information to ensure the thorough management of personal information.

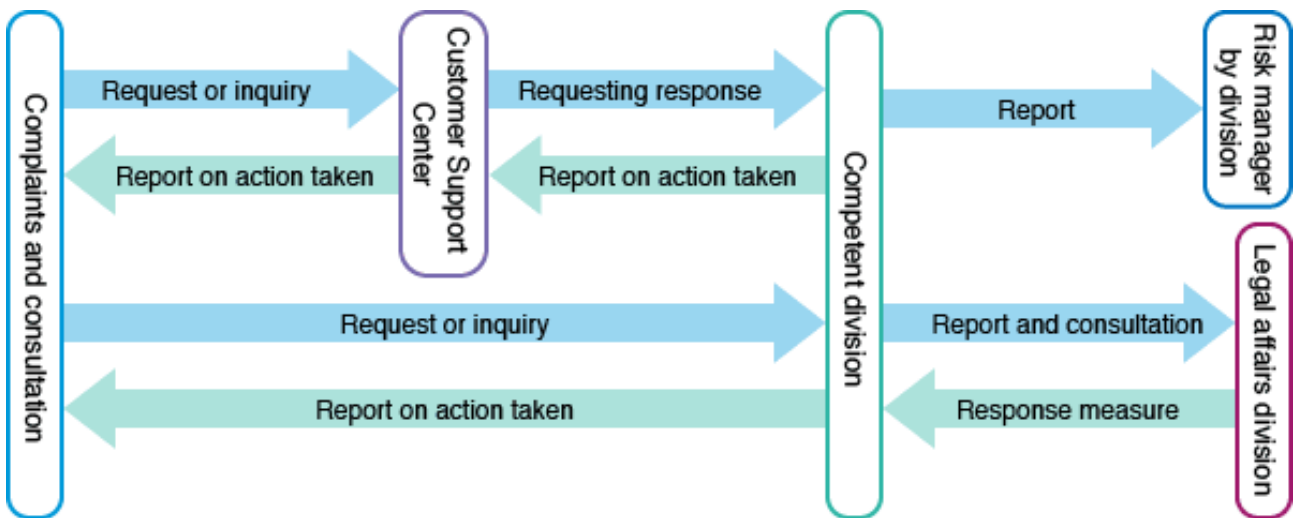

Communication system on personal information

Protection of Intellectual Property Rights

The basic policy of the Kyocera Group is to safeguard the yields of research and development by the Group as intellectual property rights, and to respect the intellectual property rights of others. We assign liaison officers responsible for intellectual properties to main offices and plants. Their role is to smooth the processes of obtaining intellectual property rights, maintaining control of rights and negotiating licenses for intellectual property rights. The Kyocera Group is undertaking activities relating to intellectual property in close cooperation with the relevant businesses.

One Approach

■ Measures for Dealing with Counterfeit Products

The Kyocera Document Solutions Inc. Group is implementing diverse measures in various countries of the world to protect customers from the harm caused by counterfeit products, and to enable product use with peace of mind. Vendors selling counterfeit products are warned and asked to pledge they will no longer handle them. They are requested to destroy stocks and reveal the names of their suppliers. By these and other means Kyocera Document Solutions endeavors to prevent growth in circulation of counterfeit products. The Group is also using hologram seals to distinguish between genuine and fake products, making it easy to determine whether a product is authentic.



Product with hologram seal attached

Thorough Legal Compliance

The Kyocera Group ensures thorough compliance with the law by taking measures including management by each division in charge of a specific law or regulation, the establishment of an in-house communication system for notification of the enactment or revision of a law or regulation, the establishment of Employee Consultation Offices (internal reporting system), and the implementation of regular legal compliance audits.

Measures for Fair and Free Competition

The Kyocera Group complies with anti-monopoly laws and related legislation, and we are working to promote fair and free competition. For example, guidelines on compliance with anti-monopoly legislation were prepared and are already being used in employee training in Group companies in Japan, the U.S.A. and Europe.

The Kyocera Group issued the Kyocera Group Global Antitrust Compliance Manual, common to the entire Group in February 2013 and distributed it to employees worldwide. We also set up a consultation office for employees to consult on antitrust laws in each region.

Furthermore, we provided education to employees in sales divisions and materials divisions, with about 8,500 employees receiving education in FY2014.



Kyocera Group Global Antitrust Compliance Manual

Security Trade Control System

The Kyocera Group complies with the Foreign Exchange and Foreign Trade Act and other regulations relating to international security. In addition, the Kyocera Group is establishing a system for heightening security trade control. The purpose is to prevent the outflow of components for weapons of mass destruction and arms, or products and technology that could be used for their production and development.

Kyocera introduced a business partner audit system in FY2014 to strengthen management. The Kyocera Group (Japan) also regularly holds meetings of the Security Trade Control (STC) Committee to ensure thorough compliance with the Foreign Exchange and Foreign Trade Control Law, and laws and regulations related to export. For overseas Group companies, Kyocera has established a system that emphasizes education on and audits of security trade control systems to enhance legal compliance.

Appropriate Information Disclosure

The Kyocera Group complies with regulations relating to the disclosure of information. The Group endeavors to provide appropriate information without falsehoods or expressions that invite misunderstanding, in accordance with social and moral principles. Additionally, display of

product labels and operating instructions, catalogs, sales promotion documents, advertisements and other materials by Kyocera is in line with the company standard as set out in our Public Document Verification Guidelines. We are building a check system for verification by the Quality Assurance, Legal, Intellectual Property and Corporate Communications divisions.

Measures for Prevention of Bribery and Corruption

For the Kyocera Group, the basis of dealings with business associates is to always be fair and just, and to approach all manner of transactions in the spirit of fair play with the correct attitude as a human being. The Kyocera Group CSR Guideline prohibits the excessive exchange of gifts, the provision and receipt of excessive entertainment, and other corrupt activities. The Guideline also forbids activities that depart from customary business practice.

Ensuring Transparency in Political Donations

The Kyocera Group may provide political donations as required from perspectives such as the realization of policy-oriented politics and contributing to the sound growth of parliamentary democracy. When we make political donations, we will comply with relevant laws and regulations including the Political Funds Control Act as well as relevant bylaws.

Measures for Prevention of Insider Trading

The Kyocera Group has established management systems to prevent insider trading and educates employees thoroughly. Kyocera has enacted Insider Trading Prevention Regulations, which establish a management system for insider information and provide restrictions on stock trading. The company prepared an Insider Trading Prevention Handbook and distributed it to employees to enhance understanding of its importance.

In FY2014, Kyocera revised this Handbook to match the revised Financial Instruments and Exchange Act going into effect in April 2014 and distributed it to all employees. In addition, we provide education on the prevention of insider trading to newly hired employees and newly promoted employees, announce stock trading prohibition periods at morning meetings, and take other measures on a regular basis.

Measures for Exclusion of Antisocial Groups

The Kyocera Group established a basic policy for corporate governance and internal control including the prevention of involvement in management activities by antisocial groups and the prevention of damage by such groups.

The basis of the measures for exclusion of antisocial groups is that “the entire company is united in confronting antisocial groups with determination.” The Kyocera Group CSR Guideline clearly specifies how to handle antisocial groups to notify all employees of the company’s attitude. In FY2014, we revised the basic business contract concluded with business partners and added a term on the elimination of antisocial groups. We intend to reinforce our handling of antisocial groups through the efforts of the entire supply chain towards their elimination.

Establishment of Employee Consultation Hot-Line Center (Internal Reporting System)

Kyocera Group employees can consult the Employee Consultation Hot-Line Center on diverse issues. Employees can seek advice and consult on diverse matters of doubt, and report actions that are or may be in violation of laws and internal regulations relating to human rights, labor, safety and health, environment, fair business practices, etc. Measures for protection of individual privacy are clarified, and employees can consult the Hot-Line Center directly by telephone, e-mail or other means. Details of the consultation are investigated and ascertained in cooperation with the relevant divisions. This is followed by corrective action and preventive measures against recurrence. At Kyocera, consultations were undertaken on 19 matters in FY2014, and steps toward resolution were taken in each case.

Legal Audit System

The Kyocera Group conducts legal audits to check the state of the Group’s legal compliance as part of measures to reinforce the compliance system. We checked the legal compliance systems of Group companies in Asia in addition to Group companies in Japan in FY2014. Kyocera has established a new legal audit system focused on business processes in FY2015 and plans to deploy the system to Group companies inside and outside of Japan sequentially.

Supply Chain Management

Policy and Systems Related to Purchasing Activities

The Kyocera Group thinks that the mutual prosperity of the entire supply chain will only be realized if all companies involved in the series of business processes including development, production, sales and service work together to meet the demands of society. To this end, the Kyocera Group actively communicates with business partners and focuses on the building of partnerships based on mutual trust. We also ensure thorough compliance with business-related laws such as the Subcontract Act, by regularly implementing in-house education and audits of personnel in charge of materials and business divisions.

Basic Policy on Purchasing

At the Kyocera Group, we are determined to contribute to value creation and business development through materials business, diligently conduct work, and coexist with business partners, thereby attempting to be better people and win society's trust. We established the Basic Policy on Purchasing with this idea as the basis of our purchasing activities. Under this policy, we conduct various surveys on corporate overviews and CSR to evaluate and select our business partners fairly.

- Whether the fundamental thinking of the Kyocera Group is understood.
- Whether the thinking of the business operator and the management rationale of the prospective supplier are acceptable to Kyocera.
- Whether the company aims to improve management ability, technological strength and manufacturing ability; and whether business management is appropriate and stable in terms of scale and finances (e.g.: VA^{*1} / VE^{*2} proposal strength).
- Whether the company excels in such areas as quality, price, delivery time, service response, etc. (e.g.: ISO 9000 series or equivalent quality management systems; lead-time reduction activity).
- Whether the company is seriously involved in global environmental conservation activity (e.g.: ISO 14001 certification).

*1Value Analysis

*2Value Engineering

Holding of Supplier Seminars and Social Gatherings

The Kyocera Group regularly holds Supplier Seminars and Supplier Social Gatherings in Japan, China and Korea. Our suppliers are invited to these gatherings to allow them to better understand the management policies and business policies of the Kyocera Group, and to request their continued cooperation. Supplier Seminars were held in Kyoto and Mie (Japan) in FY2014, with a total of 149 people participating from 110 companies. At the Supplier Social Gathering held in Kyoto, three suppliers were awarded for their excellent quality, pricing and delivery performance in the past year of business.



Award ceremony at a Supplier Social Gathering

CSR Deployment in the Supply Chain

The Kyocera Group works on the promotion of CSR activities together with business partners in order to better undertake corporate social responsibility covering various issues including human rights, labor and environmental protection, including within our business partners.

A variety of CSR issues emerged that had to be addressed across the entire supply chain, including conflict minerals and the formulation of a BCP for swift business recovery and continuation in the event of disasters. In response, Kyocera amended its Supply-Chain CSR Deployment Guideline.

We sent the Guideline to our business partners in Japan and monitored the current status of their efforts with regard to CSR activities.

Specifically, we asked for their cooperation with our survey on matters such as human rights and labor, the environment, occupational safety and health, fair trading and ethics, quality and safety, business continuity plans (BCP), and information security. We asked business partners whose action with regard to certain matters was found to be insufficient to work on CSR activities more proactively.

We will also deploy CSR activities for business partners and Group companies overseas.

Kyocera promotes green procurement to reduce environmental impact related to products and, apart from the Supply-Chain CSR Deployment Guideline, has also prepared the Kyocera Guideline on Environmentally Hazardous Substances and the Kyocera Guideline on Environmental Protection Activities, requesting the cooperation of business partners. (see page 87)

Reporting on Conflict Minerals

Knowing that some revenue of minerals produced from the Democratic Republic of the Congo and its neighboring countries in Africa — including columbite-tantalite (tantalum), cassiterite (tin), gold, wolframite (tungsten), and their derivatives — are used to fund armed groups that commit human-rights violations, the Dodd-Frank legislation of July 2010 designates these minerals as “conflict minerals” regardless of where they are produced and requires all companies listed on the New York Stock Exchange to disclose information on the use of these minerals in their products.

Kyocera Group Policy and Organization Structure

Kyocera’s policy is not to purchase conflict minerals or materials and products using metals made from conflict minerals, the revenue of which may serve to fund armed groups committing human-rights violations in the Democratic Republic of the Congo and neighboring countries. In the “Kyocera Supply-Chain CSR Deployment Guideline” we have added a policy regarding conflict minerals.

In order to address this issue and consider appropriate measures, Kyocera established the Kyocera Conflict Minerals Committee in 2012, which is comprised of the top managers in purchasing, investor relations, corporate social responsibility, internal audit and legal affairs.

The Committee’s role is to determine the basic policies and investigation methods regarding conflict minerals and to ensure that the entire Kyocera Group addresses the conflict mineral issue properly and fairly. Since this issue needs to be addressed by the entire supply chain, we are actively working with industry organizations and will continually work to improve cooperation. Kyocera has been a principle member of the Responsible Investigation Commission of Conflict Minerals, established within JEITA^{*1}, since its inauguration. We led the instruction at meetings to explain the conflict minerals surveys held by JEITA and JAPIA^{*2} from May to June 2013.

*1 JEITA: Japan Electronics and Information Technology Industries Association

*2 JAPIA: Japan Auto Parts Industries Association

The Kyocera Group’s Measures and Survey Results

In August 2012, following the announcement of detailed regulations relating to the conflict minerals provision in the U.S. financial regulatory reform bill, Kyocera internally decided on the most salient points of an industry-supported survey. As conflict minerals present industry-wide issues, we decided to carry out investigations based on the framework of the Conflict Free Smelter (CFS) Program created by the Electronics Industry Citizenship Coalition (EICC) and the Global e-Sustainability Initiative (GeSI).

Since January 2013, Kyocera has held 20 explanatory meetings in Japan (Tokyo, Kyoto, Osaka and Kagoshima) and China (Shanghai and Dongguan), where Kyocera’s suppliers are mainly concentrated, to explain policies for dealing with conflict minerals and to request cooperation with the survey. A total of 897 companies were in attendance.



Explanatory meetings for suppliers (left: Japan; right: China)

We started the survey in February 2013 and have continually analyzed the completed surveys received from our suppliers. We conducted a survey with our suppliers on the country of origin related to minerals, for which 93.8% of the surveys were returned. For suppliers who handle minerals originating from the Democratic Republic of the Congo and its neighboring countries, it is necessary to conduct due diligence in accordance with the rules of the U.S. Securities and Exchange Commission. Therefore, we directly contacted these suppliers as “critical suppliers to survey” and confirmed the name and location of the smelters or refiners used for their minerals.

The results show that the Kyocera Group has no relation with the relevant conflicts at this point.

Kyocera Group’s Future Measures

The Kyocera Group recognizes the importance of continuing its survey using the CFS program and in identifying and investigating smelters and refiners.

Therefore, we intend to continually establish a strong supply chain relationship through various measures, including the signing of a letter of engagement with suppliers that includes a pledge to contact Kyocera immediately if a connection to a conflict mineral has been uncovered.

It is important to increase the number of smelters that submit to an independent third-party audit in order to be assessed as “conflict-free.” However, since it is difficult for a single company to prompt smelters to participate in such audits, Kyocera continues to work through industry organizations such as JEITA for this purpose.

One Approach

■ Approach by Overseas Group Company

As the leading supplier of tantalum capacitors, AVX Corporation (AVX), a consolidated subsidiary of Kyocera in the United States, has continued its efforts to remove from its supply chain any conflict minerals which may serve as funding sources for armed groups committing human-rights violations. AVX announced that as of December 1, 2011 all its current tantalum powder and wire suppliers were fully compliant with the independently audited CFS Program. AVX will continue to exclusively use tantalum powder and wire from conflict-free compliant smelters in accordance with the principles of the Dodd-Frank legislation and current Organization for Economic Co-operation and Development (OECD) guidelines.

Approaches to Raising Quality and Customer Satisfaction Levels

Efforts to Improve Product Quality

Kyocera Quality Policy

The Kyocera Group has established the Kyocera Quality Policy to achieve production of quality goods that fully satisfy our customers' needs. We develop our businesses on the basis of this Quality Policy, and aim to always be an enterprise that is worthy of trust throughout the world. Moreover, to provide a high level of satisfaction to our customers, Kyocera is doing everything possible to ensure observance and correct application of the rules, starting at the planning stages.

■ Kyocera Quality Policy

1. Kyocera places top priority on our environmental management and product safety systems.
2. Kyocera provides products and services to our customers that exceed their expectations by putting them first.
3. Kyocera aims to be a world leader in quality by doing every job right the first time.

Quality Management Systems

The Kyocera Group holds meetings of the Kyocera CS Improvement Committee with the President serving as its chairman every month to improve the CS index, share quality information to prevent quality problems, and prevent the recurrence of quality problems.

The company has established quality management systems including ISO 9001, and each business unit sets its own quality targets, formulates plans and carries out quality improvements towards their achievement.



Kyocera CS Improvement Committee

One Approach

■ Quality Training Held in China

The Kyocera Group holds quality training regularly to improve quality indices and reinforce quality systems. In FY2014, the company provided quality training to about 200 Chinese employees, including managers in the vehicle-mounted product-related Technical and Manufacturing Divisions of Dongguan Shilong Kyocera Co., Ltd. and Kyocera Display (Zhangjiagang) Co., Ltd. in China. Trainees improved their practical abilities to become able to respond smoothly to quality problems through practical drills with Kyocera-style system diagrams and other materials. We will improve quality further by implementing ongoing training in the future.



Quality training (China)

Efforts to Ensure Product Safety

Kyocera Product Safety Policy

Safety is the utmost priority for all products made or sold by Kyocera. Regardless of form or function, they must not endanger a person's life or well-being, nor inflict damage on property. From this perspective, Kyocera has set a Product Safety Policy, in addition to its Quality Policy.

Kyocera established Product Safety System Guidelines as a concrete code of action at all levels of corporate activity. Additionally, the Guidelines for Product Safety Labeling serve as supplementary guidelines for understanding international standards relating to safety labels.

■ Kyocera Product Safety Policy

1. Kyocera is fully acquainted with the latest information related to product liability and product safety.
2. Kyocera maintains an industry-leading standard of product safety.
3. Kyocera systematically practices product safety in accordance with manuals.

Responses to Accidents Involving Products

We have established systems that allow the CS Division and Risk Management Division to gather information and implement countermeasures if a serious product accident occurs. We also notify the competent authority of such accidents and disclose information on our Web site.

Approaches to Raising Customer Satisfaction Levels

Action by the Customer Support Center

The Kyocera Group operates a Customer Support Center (Call Center) to handle matters mainly concerning products for general consumers. By responding earnestly, correctly and promptly to customer inquiries, consultations, complaints and other issues, the Kyocera Group aims to raise the level of customer satisfaction.

Valuable information and inquiries received from our customers are promptly reported to top management and shared among the relevant business segments. The information received is used to improve the quality of our products and services.

In FY2014, Kyocera received 54,236 inquiries, about 20,000 more than in FY2013, mainly because of an increase in the number of questions on relating to smartphone operation.

Safeguarding Customer Personal Information

In the Kyocera Group, the personal information of customers is as a rule obtained directly from customers, upon agreement with the customers, and only after clarification of the purpose for which it would be used is provided. Personal information stored by the Kyocera Group is handled appropriately in accordance with strict controls based on the Electronic Information Security Management Policy and associated regulations.

Efforts of Universal Design

Kyocera Document Solutions Inc. incorporates the concept of User Centered Design in its development process. Under this concept, users are always at the center of the life cycle of products such as printers and multi-functional products (MFPs), covering planning, design, production and sale; and products are designed based on information gathered from users and a good understanding of what they want.



Wheelchair usability evaluation

Particularly in the design stage, it is important to understand customers' needs and repeat the production and evaluation of prototypes. This is how the company realizes the supply of easy-to-use products and user-friendly services. Engineers and designers whose job is to develop products actually visit workplaces where people with disabilities work, as well as place themselves in wheelchairs or wear special kits in order to recreate the physical experience of elderly people so that they can better understand the needs of diverse people. What they learn is then incorporated into the verification and development of products.

One Approach

■ Kyocera Received the Minister of Economy, Trade and Industry Award in the CEATEC AWARD 2013

The CEATEC AWARD 2013 was announced at the opening event of CEATEC JAPAN 2013, one of Asia's largest general exhibitions of advanced IT and electronics. Kyocera's piezo film speaker (Smart Sonic® Sound), one of Kyocera's new acoustic devices, received the Minister of Economy, Trade and Industry Award. The CEATEC AWARD 2013 are given to technologies, products and services on display at CEATEC JAPAN 2013 which possess particularly excellent features. The winning items were evaluated highly for their future potential and marketability.

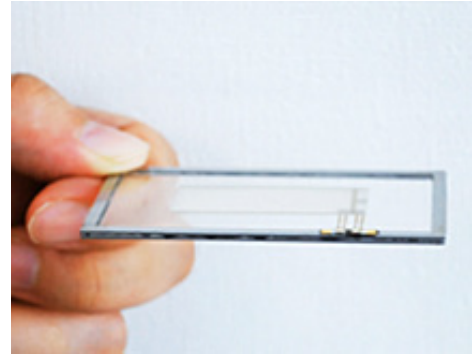

Smart Sonic® Sound

■ Kyocera Received the iF Product Design Award 2014, a German Design Award

Kyocera's DIGNO® M smartphone received the iF Product Design Award 2014 at the iF Design Awards sponsored by iF International Forum Design GmbH. The award is presented for industrial products of excellent design not only from Germany but from all over the world. It is an internationally renowned design award and the most prestigious in Europe, the birthplace of modern industrial design. Highly evaluated for its functionality and ease of use, the DIGNO M was selected and presented with the award in the product category, which screened industrial products.



Kyocera DIGNO® M smartphone

Supporting Academic Advancement and Research

Supporting the Inamori Foundation's Kyoto Prize

The non-profit Inamori Foundation was established in 1984, based upon the belief of Kyocera's founder, Kazuo Inamori, that "a human being has no higher calling than to strive for the greater good of humanity and the world" and that "the future of humanity can be assured only when there is a balance between scientific development and the enrichment of the human spirit." The Kyoto Prize, organized by the Foundation, was established in 1985 and celebrates its 30th anniversary in 2014 as an international award that honors people who have made significant contributions in the three categories of Advanced Technology, Basic Sciences, and Arts and Philosophy. Each laureate receives a diploma, Kyoto Prize medal and prize money of 50 million yen per category.

Following the Kyoto Prize presentation ceremony each November 10, events are held to encourage citizen interaction with the laureates, including commemorative lectures for the general public where the laureates present their world views, academic workshops involving experts in the chosen award fields, and educational programs for students from elementary school to college.

The Kyocera Group is fully aligned with the spirit of the Kyoto Prize and pleased to support this award.



The Kyoto Prize Presentation Ceremony



The 2013 Kyoto Prize laureates



Kyoto Prize Symposium held in San Diego (U.S.A.)

Inamori Frontier Research Center at Kyushu University

The Inamori Frontier Research Center was established at Kyushu University (Fukuoka Prefecture, Japan) to undertake research activities contributing to the harmony of minds and technology, and to support the exchange and education of young researchers. Kyocera agrees with the goals of the Center, and has supported its operations since 2008 by donating scholarship funds.



Inamori Foundation Memorial Hall housing the Inamori Frontier Research Center

Inamori Academy Building at Kagoshima University

In 2008, the Inamori Academy building opened at Kagoshima University (Kagoshima Prefecture, Japan) to offer a course aimed at the comprehensive cultivation of human abilities. Kyocera supported the construction of the facility. In 2000, the endowed Kyocera Chair of Management Studies was established in the university's Faculty of Engineering. In 2005, the course expanded university-wide and was reorganized into the Inamori Academy in 2008.



Inamori Academy building

Donation of the Kyocera Collection of British Parliamentary Papers

In 1998, Kyocera donated more than 12,000 volumes of documents submitted to the British Parliament in the 19th and 20th centuries to Japan's National Museum of Ethnology. The collection was transferred to the Center for Integrated Area Studies (CIAS), Kyoto University in 2006 and is utilized as a resource for research.



Kyocera Collection of British Parliamentary Papers

Alfred University

In 2005, Kyocera made a donation to Alfred University (New York state, U.S.A.), an institute renowned worldwide for its education and research in ceramics and glass, which led to the official renaming of its engineering school as the Kazuo Inamori School of Engineering. In 2011, the Inamori Kyocera Fine Ceramics Museum was opened to exhibit the products and technology that Kyocera has cultivated over the years.



Inamori Kyocera Fine Ceramics Museum

Kyocera Museum of Fine Ceramics

The Kyocera Museum of Fine Ceramics was inaugurated in 1998 in the global headquarters building in Kyoto, followed by a sister museum in the company's Kagoshima Kokubu Plant which opened in 2001. Free of charge and open to the public, the museums showcase the evolution and latest technological advances around which Kyocera has grown and serve to support the future development of fine ceramics. The museum in Kyoto was fully renovated in March 2014.



The Kyocera Museum of Fine Ceramics

Support for Culture and the Arts

Shiki Theatre Company's Kokoro no Gekijo

Kyocera supports Kokoro no Gekijo (theatre of the heart), planned and managed by the Shiki Theatre Company, which uses the stage to communicate to children such important life lessons as trust, altruism and the value of life. Children across Japan are invited to attend the free performances.



The Emperor's New Clothes, performed by Shiki Theatre Company
(Photo by Akihito Abe)

The Kirishima International Music Festival

Since 2001, Kyocera has supported the Kirishima International Music Festival (Kirishima City, Japan) with the aim of providing students with the opportunity to be educated by outstanding musicians and experience their performances. Concerts and workshops are held every year, featuring musicians from around the world as invited performers and lecturers.



Concert at the Kirishima International Music Festival

© Kirishima International Music Festival

Kyoto Hanatouro Project

Kyocera supports the Kyoto Hanatouro project, in which lights and flowers evoking a rich Japanese atmosphere are used to decorate Kyoto's prominent temples, shrines and other historical cultural assets and street scenes. More than two million people enjoyed fantastic night scenery during events over 20 days in Arashiyama in December 2013 and Higashiyama in March 2014.



Arashiyama, Kyoto vividly illuminated
(Photo provided by Kyoto Hanatouro Promotion Council)

The Kyocera Museum of Art

The Kyocera Museum of Art, which is open to the public free of charge, was established in 1998 in the Kyocera headquarters building (Kyoto City, Japan). Many works of art are on permanent display, including Picasso's copper plate print series 347, Western-style paintings, sculptures, and Qianlong glass from China. From March to April 2014, the Museum's Spring Special Exhibition featured cultural assets dating from the Azuchi-Momoyama Period to the end of the Edo Period that relate to the Fushimi district of Kyoto.



The Kyocera Museum of Art

International Exchange and Collaboration

Donating of Solar Power Generating Systems to Schools in Uganda, Tanzania and Nepal

To help improve the educational environment in areas lacking electricity, Kyocera has donated solar power generating systems and basic electrical equipment, including lighting, TVs and radios, to schools in Uganda, Tanzania and Nepal since 2009.

As a pioneer in solar power, Kyocera can help improve educational standards in developing countries by giving children — our future leaders — classrooms lit by solar electricity.



Donation ceremony held at a school (Uganda)



Schoolchildren watch a television powered by solar energy (Uganda)



School staff and a Kyocera employee (at far right) hold a donation ceremony (Tanzania)



Solar modules installed at a school (Nepal)

Supporting “TOMODACHI in San Diego”

Many survivors of the Great East Japan Earthquake received assistance and were heartened by Operation Tomodachi, an emergency rescue effort conducted by U.S. Armed Forces in the wake of the disaster. Building upon the spirit of friendship, the TOMODACHI Initiative was created by the U.S. Embassy in Japan and the U.S.-Japan Council. In alliance with the Initiative’s goals, Kyocera, together with Japan Airlines, supports programs designed to give hope and courage to children in Japan’s affected regions.



High school students visiting Marine Corps base to express gratitude

The Inamori-Kyocera Western Development Scholarship Fund Supports Development in China

In 2001, Kyocera and its founder, Kazuo Inamori, set up the Inamori-Kyocera Western Development Scholarship Fund to assist economically disadvantaged university students in China’s western provinces who show both outstanding academic achievement and high moral character. The fund fosters individuals who will aid regional development through science and technology.

Scholarship funds are granted at 12 universities each year, with a total of 3,576 student beneficiaries as of March 2014.



Scholarship recipients

Providing Scholarships to Japanese Language Students

For more than 30 years, KYOCERA International, Inc. has provided Kyocera Japanese Scholarships and Best Student Awards to students at San Diego State University. These annual partial scholarships and awards recognize outstanding students of Japanese language and encourage cross-cultural studies.



President of Kyocera International, Inc. (left) presents a student (right) with an award

Cultural Exchange Tours Enable Chinese Children to Visit Japan

Since 1997, Kyocera has invited children from China to visit Japan, with the hope that providing firsthand experience of different cultures to children will facilitate future bonds of friendship between the two countries. A total of 394 children have taken part in the program so far. The summer of 2013 marked the 14th time this tour has been held, with 30 children visiting Japan from Shanghai to travel around Tokyo, Yamanashi, Shiga and Kyoto.



Chinese children visiting a Kyocera plant

Picture Books for Children in Developing Countries

Kyocera Communication Systems Co., Ltd. (KCCS) supports an international cooperative that delivers picture books to children in developing countries. Since 2009, KCCS employees and their family members have voluntarily made picture books, which are delivered to children in countries including Cambodia, Laos, Afghanistan, and at refugee camps in Myanmar (Burma).



Employees volunteering to make picture books

Local Community Activities

Japan

Supporting Kyoto Sanga F.C. Professional Soccer Team

Kyoto Purple Sanga (now Kyoto Sanga F.C.) was established in 1994 in response to the high expectations of Kyoto residents calling for a local professional soccer team. In the belief that it is the responsibility of a local company to help its community thrive, Kyocera provides Group-wide support to this team. Kyocera also supports the Sanga Cup, a Kyoto youth soccer tournament, as well as a project that helps develop soccer skills in players up to the age of 18.



©KYOTO.P.S.

Classes in Scientific Experimentation Teach Basics of Electricity and Photocopying

The Osaka City Board of Education conducts the Naniwa "Kids Love Science Development Project" to help children experience the joy of learning science and to ensure the future of the manufacturing sector. Kyocera employees have served as special instructors since 2008, using scientific experiments to teach a total of 2,352 elementary school students in 32 schools how science can be fun.



Printer/copier science experiments

Cooperation in the Display of Artificial Joints at the Osaka Science Museum

Kyocera Medical Corporation has cooperated with the Osaka Science Museum in the display of artificial joints since 2008. Artificial hip joints are on display in a Familiar Chemistry corner. The purpose of the display is to let people know how biocompatible materials are used effectively in the medical field.



A family looking at artificial hip joints on display



Cooperating in a Display at the Kyoto Manufacturing Hall of Fame

The Kyoto Manufacturing Hall of Fame is an exhibition space for local businesses which was opened in 2009 at a facility in Kyoto to provide elementary school and junior high school students with opportunities to learn about society. Kyocera displays products and other items on manufacturing and holds industrial lessons using solar cells. Children visit this facility as part of their curricular activities and learn the importance of manufacturing as they get hands-on experience with technology and products.



Elementary school students visiting the Kyocera exhibition corner

Pink Ribbon Activities

The Kyocera Group supports the Pink Ribbon Movement to promote early detection and diagnosis of breast cancer, and donates part of the profits from its pink ceramic kitchen products to this effort. In the U.S.A., Kyocera has donated part of the profits from its pink-handled ceramic knives to breast cancer research since 2004. Kyocera supports similar activities in Australia, China, France, Italy, Korea and Japan.



Ceramic knife series supports the Pink Ribbon Movement

Sponsoring Local Festivals / Summer Festival at Plants and Offices

The Kyocera Group actively sponsors local festivals and events to invigorate the local communities where Kyocera's plants and offices are located. Kyocera sites all over the country have been holding summer festivals every year since 1972 and value communication with local residents.



Employees participating in the Kirishima Kokubu Summer Festival

Local Beautification Activities

Kyocera aims to be an integral part of its local communities, participating in beautification efforts for parks, forests, rivers and areas around the company's offices and plants worldwide. By carrying out regular cleanups and taking part in local initiatives, the company continually aims to beautify its communities.



Employees cleaning the community in Yokohama, Japan

Support for the All-Japan Wheelchair Rider Ekiden

The aim of the All-Japan Wheelchair Rider Ekiden is to promote social participation and sports activities by people with disabilities. Kyocera has supported the race since it was first run in 1990



Wheelchair rider

Christmas Illuminations

Each year from the end of November through December, Kyocera festively illuminates its global headquarters building in Kyoto with LED lighting to enliven the local community. During the Christmas season, the headquarters building becomes a huge shining fir tree with the clever arrangement of lighted windows. In 2013, many visitors enjoyed strolling in the headquarters courtyard which was decorated by approximately 210,000 LED light bulbs.



LED illuminations



Photo taken with "pen light art"

Group-Wide Fund-Raising Efforts

The Kyocera Group (Japan) provides Group-wide support for year-end fund-raising activities every year. Kyocera started donations in 1963 immediately after its foundation. Contributions from employees and Kyocera are entrusted to local communities. In addition, many Kyocera Group companies inside and outside of Japan make donations in support of disaster-stricken communities around the world. Kyocera employees also hold fund-raising campaigns and carry out volunteer activities.



Employees engaged in a volunteer activity at the children's orphanage and infant care facility, Kyoto Daiwa-no-Ie, where the Group's donations are utilized.

Advanced Chemical Technology Center in Kyoto

In November 2013, the Advanced Scientific Technology & Management Research Institute (ASTEM) of Kyoto inaugurated the Advanced Chemical Technology Center in Kyoto as a new research and development base. Kyocera donated a 10kW solar power generating system to support the Center's activities, aimed at promoting cutting-edge industry-academia cooperative projects.



Roof of the Advanced Chemical Technology Center

Outside Japan

Providing Materials for International Robotics Competition

Kyocera Crystal Device (Thailand) Co., Ltd. in Thailand helped support a team from King Mongkut's University of Technology Thonburi, which represented Thailand in the international "RoboCup 2013" (Netherlands) competition by providing components. The competition is held to promote the development of intelligent robots.



Winning students in category of "Robocup Rescue"
(Photo courtesy of King Mongkut's University of Technology Thonburi (Bangkok))

Entrepreneurial Learning for Kids

Kyocera Document Solutions Espana, S.A. supports Fundación Marazuela, an organization in Madrid working to promote the social and cultural development of the local region. Kyocera collaborated on a program in which children learned about business enterprises and established their own imaginary company to sell products.



Children selling products for their imaginary company

Supporting the “Avnet Tech Games” College Technical Competition

In 2011, the Kyocera Solar, Inc. created a “solar scrimmage” for an Arizona technical college competition in which students created solar-powered pumping systems based on engineering skills learned in school. The company supports students at the local competition every year by donating solar modules and providing event support.



Students creating solar-powered pumping systems

Donations to Local Elementary Schools

In November 2013, Kyocera Solar Europe s.r.o. in the Czech Republic donated computers and other equipment to four elementary schools in the town of Kadan to bolster local education. In addition, solar modules were donated, some of which are used as educational tools to teach children about solar energy.



Kyocera employees donating equipment

Financial Cooperation for an Entrepreneur Support NPO

Kyocera Document Solutions South Africa (Pty) Ltd. provides financial support for The Hope Factory, an NPO working to empower impoverished people to start their own businesses. The NPO provides knowledge on financial management and marketing to assist people starting various businesses such as selling security equipment.



Employees receiving entrepreneurial support

Supporting Cancer Prevention

Kyocera Document Solutions Australia Pty Ltd. supported the “Daffodil Day” charity fundraiser, which is held every year to support cancer patients and research. Teddy bears, pens and other goods were sold in the office and the proceeds were donated to Cancer Council Australia.



Employees participating in the charity event

Supporting the Education of University Science Students

Kyocera America, Inc. began collaborating with Mathematics, Engineering, Science Achievement (MESA) in 1992 to support students in their studies. Providing educational support and scholarships to universities in the state of California helps highly motivated students achieve their academic goals.



University students receiving scholarships (left and right) from a Kyocera employee (center)

Educational Support to a Vocational School

Since 2012, Kyocera Document Technology (Dongguan) Co.,Ltd. in China has helped a vocational school in Zigui County, Yichang City, Hubei Province by supporting practical training such as computer work and machine repair / assembly. To help enhance human resources development, Kyocera also grants scholarships to outstanding students.



Scholarship ceremony

Playground Construction at a Local School

Since 2007, Kyocera Crystal Device (Thailand) Co.,Ltd. in Thailand has participated in local development programs to support communities in need and underprivileged children. In August 2013, Kyocera employees helped build a playground and make other improvements at Ban Huai Hom School in Lamphun Province. More than 150 volunteers and students took part in the program, working together to improve the school's infrastructure.



Volunteers building a playground at Ban Huai Hom School

Holiday Donations in Local Communities

The Kyocera Group in the U.S.A. supports initiatives to make year-end holidays a special time for people in the community. In Washington, employees took part in the Adopt-a-Family Program, in which items requested by local families in need were donated as holiday gifts. The New Jersey office participated in the annual Toys for Tots campaign, run by the U.S. Marine Corps, which collects toys and delivers them to underprivileged children.



Kyocera employees with holiday gifts for donation

ISO9001 Certification Status

Integrated Certification (6 companies)

(as of April 2014)

地域	Company	Date of registration
Japan	KYOCERA Corporation	Jul. 1992 (Registration No.: JMI-0036)
	KYOCERA OPTEC Co., Ltd.	
	KYOCERA Document Solutions Inc.	
	KYOCERA SLC Technologies Corp.	
	KYOCERA Chemical Corp.	
	KYOCERA Solar Corp.	

Individual Certification (39 companies)

(as of April 2014)

Region	Company	Date of registration		
Asia	Japan	KYOCERA Connector Products Corporation *1	Jul. 2008	
		KYOCERA Crystal Device Corporation	Mar. 1998	
		KYOCERA Medical Corporation *2	May 2005	
		KYOCERA Communication Systems Co., Ltd.	Aug. 1997	
		Six divisions related to computer systems and package software		
		Two divisions related to mobile base stations		
		KYOCERA Display Corporation		Aug. 2005
		KYOCERA Circuit Solutions, Inc.	Apr. 1993	
	China	Shanghai KYOCERA Electronics Co., Ltd.	Dec. 1998	
		Dongguan Shilong KYOCERA Co., Ltd.	Feb. 2003	
		KYOCERA Document Technology (Dongguan) Co., Ltd.	Feb. 1994	
		KYOCERA Chemical (Wuxi) Co., Ltd.	Apr. 2004	
		KYOCERA (Tianjin) Solar Energy Co., Ltd.	Jul. 2004	
		KYOCERA Display (Zhangjiagang) Co., Ltd.	Sep. 2006	
		KYOCERA Connector Products Hong Kong Ltd.	Mar. 2004	
		KYOCERA Document Technology Co., (H.K.) Ltd.	Feb. 1994	
		AVX Electronics (Tianjin) Co., Ltd. *1	Sep. 2007	
		Singapore	KYOCERA Connector Products Asia Pte, Ltd.	Oct. 2004
	KYOCERA Chemical Singapore Pte, Ltd.		Mar. 2003	
	Korea	KYOCERA Connector Products Korea Co., Ltd.	Apr. 1998	
		KYOCERA Precision Tools Korea Co., Ltd.	Feb. 2004	
	Thailand	KYOCERA Crystal Device (Thailand) Co., Ltd. *1	Sep. 2003	
	Malaysia	TPC Malaysia Sdn.Bhd.	Mar. 2004	
	Philippines	KYOCERA Crystal Device Philippines, Inc. *1	Mar. 2004	
	Israel	AVX Israel Ltd.	Dec. 2003	
	North America	U.S.A.	KYOCERA America, Inc.	Apr. 1994
			KYOCERA Industrial Ceramics Corporation	Apr. 1995
KYOCERA TYCOM Corporation			Aug. 1996	
AVX Corporation			Biddeford	Nov. 2004
			Colorado Spring	Jul. 2003
			Conway	Jul. 2004
			Myrtle Beach *1	Jul. 2005
			Olean	Dec. 2003
			Raleigh	Jul. 2004
AVX Filters Corporation			Dec. 2003	
American Technical Ceramics Corp.		Huntington	Oct. 1997	
		Jacksonville	Oct. 1998	
South and Central America		Mexico	KYOCERA Mexicana, S.A. de C.V.	Jun. 2005
			Avio Excelente, S. de R.L. de C.V. *1	Jan. 2004
		El Salvador	AVX Industries, Pte. Ltd. *1	Dec. 2003
Brazil		AVX Componentes da Amazonia Ltda.	Jan. 2004	
Europe		Sweden	American Technical Ceramics Europe Aktiebolag	Jan. 2003
			UK	AVX Limited *1
		France	TPC S.A.S *1	Dec. 2007
		Germany	ELCO Europe GmbH *1	May 2007
	Czech	KYOCERA Solar Europe s.r.o.	Lanskroun	Feb. 2006
			Uherske *1	Oct. 2007 *3
		AVX Czech Republic s.r.o.		Dec. 2007 *4

*1 Certification of the quality management standard (ISO/TS-16949) to which automotive special requirements are added based on ISO 9001.

*2 Certification of the quality management standard (ISO 13485) to which medical-related special requirements are added based on ISO 9001.

*3 Related to connectors. *4 Related to electronic parts and capacitors.

ISO14001 Certification Status

Integrated Certification (182 sites)

(as of April 2014)

Region	Company Office / Plant					Date of registration		
Japan	KYOCERA Corporation	Headquarters	Hokkaido Kitami Plant	Fukushima Tanagura Plant	Chiba Sakura Office	Tokyo Yaesu Office	Oct. 1996 (Registration No. EC99J2032)	
		Tokyo Harajuku Office	Yokohama Office	Nagano Okaya Plant	Mie Ise Plant	Shiga Gamo Plant		
		Shiga Yohkaichi Plant	Shiga Yasu Plant	Kyoto Fushimi Office	R&D Center, Keihanna	Osaka Daito Office		
		Kagoshima Sendai Plant	Kagoshima Kokubu Plant	R&D Center, Kagoshima	Kagoshima Hayato Plant	Sapporo Sales Office		
		Tohoku Sales Office	Nagaoka Sales Office	Takasaki Sales Office	Utsunomiya Sales Office	Okegawa Sales Office		
		Omiya Sales Office	Tachikawa Sales Office	Kanto Logistics Center	Atsugi Sales Office	Kanazawa Sales Office		
		Matsumoto Sales Office	Hamamatsu Sales Office	Nagoya Sales Office	Mikawa Sales Office	The Inamori Library		
		Kyocera Keiaikan	Osaka Sales Office	Himeji Sales Office	Okayama Sales Office	Hiroshima Sales Office		
		Kyushu Sales Office	Okinawa Sales Office	CV Ginza Store	CV Kyoto Store	CV Osaka Umeda Store		
		CV Kobe Sannomiya Store						
		KYOCERA Connector Products Corporation	Headquarters	Okaya Plant	Osaka Sales Office	Nagoya Sales Office		Omiya Sales Office
			Tachikawa Sales Office	Matsumoto Sales Office				
		KYOCERA OPTEC Co., Ltd.	Headquarters	Chigase Plant	Tokyo Sales Office	Kansai Sales Office		
	KYOCERA Document Solutions Inc.	Headquarters	Hirakata Plant	Tamaki Plant	Tokyo R&D Center			
	KYOCERA Document Solutions Japan Inc.	Headquarters	Sapporo Office	Sendai Office	Nagoya Office	Osaka Sales Office		
		Hiroshima Office	Fukuoka Office	Sales Offices: 48 locations (including local offices)				
	KYOCERA Chemical Corp.	Headquarters	Kansai Branch	Kyushu Branch	Kawasaki Plant	Kohriyama Plant		
		Moka Plant						
	KYOCERA SLC Technologies Corp.	Headquarters	Shiga Yasu Plant	Kyoto Ayabe Plant	Kagoshima Sendai Plant	Higashi Nihon Sales Office		
		Kyushu Sales Office						
	KYOCERA Crystal Device Corporation	Headquarters	Hokkaido Mikasa Plant	Nagano Okaya Plant	Shiga Yohkaichi Plant			
	KYOCERA Medical Corporation	Headquarters	Tokyo Sales Office	Kobe Plant	Shiga Gamo Plant	Shiga Yohkaichi Plant		
		Shiga Yasu Plant	Research Center	Kobe Product Control Center	Sapporo Sales Office	Tohoku Sales Office		
		Omiya Sales Office	Nagoya Sales Office	Kyoto Sales Office	Okayama Sales Office	Hiroshima Sales Office		
		Kyushu Sales Office						
	KYOCERA Communication Systems Co., Ltd.	Headquarters	Tokyo Branch	Tokyo 1st Data Center (2 sites)	Tokyo 2nd Data Center	Tokyo 3rd Data Center		
		Takanawa Branch	Shiga Office	Kyoto Karasuma Office	Osaka Office	Osaka ICT Branch		
		Fukuoka Office	Sendai Office	Kokubu Office	Sapporo Sales Office	Sendai Sales Office		
		Nagoya Sales Office	Kanazawa Sales Office	Hiroshima Sales Office	Takamatsu Sales Office	Kagoshima Sales Office		
		Headquarters	Tokyo Branch	Tohoku Sales Office	Nagoya Sales Office	Osaka Sales Office		
	KYOCERA Solar Corp.	Okayama Sales Office	Hiroshima Sales Office	Kyushu Sales Office	Sakura Office	Shiga Yohkaichi Office		
		Kagoshima Sales Office	KYOCERA Solar FC Lake Town	KYOCERA Solar FC Itami Koya				

※ The above 182 offices and plants are jointly ISO 14001 certified under the Kyocera Group Integrated Environment & Safety Management System.

Individual Certification (101 sites)

(as of April 2014)

Region	Company	Office / Plant	Date of registration	
Asia	Japan	AVX Tantalum Asia Corp.	—	Sep. 2001
	China	Shanghai KYOCERA Electronics Co., Ltd.	—	Jul. 2000
		Dongguan Shilong KYOCERA Co.,Ltd.	—	Jun. 2006
		Kyocera Document Technology (Dongguan) Co.,Ltd.	—	Oct. 2001
		KYOCERA Chemical (Wuxi) Co., Ltd.	—	Apr. 2001
		KYOCERA Document Technology Co., (H.K.) Ltd.	—	Oct. 2008
		AVX Electronics (Tianjin) Co.,Ltd.	—	Feb. 2008
		KYOCERA Document Solutions Hong Kong Ltd.	—	Nov. 2000
		KYOCERA Document Solutions Asia Ltd	—	Apr. 2012
		KYOCERA Document Solutions (China) Corp.	—	Dec. 2012
		KYOCERA (Tianjin) Solar Energy Co., Ltd.	—	Aug. 2009
		KYOCERA Connector Products (Dongguan) Co., Ltd.	—	Dec. 2003
		KYOCERA Display (Zhangjiagang) Co. Ltd.	—	Mar. 2003
		KYOCERA OPTEC (Dongguan) Co., Ltd.	—	Dec. 2003
	KYOCERA Document Solutions Taiwan Corporation	—	Jan. 2008	
	Singapore	KYOCERA Chemical Singapore Pte. Ltd.	—	Jun. 1999
		KYOCERA Document Solutions Singapore Pte. Ltd.	—	Feb. 2008
	Korea	KYOCERA Connector Products Korea Co., Ltd.	—	Spt.1999
		KYOCERA Document Solutions Korea Co., Ltd.	—	Feb. 2010
	Thailand	KYOCERA Crystal Device (Thailand) Co., Ltd.	—	Dec. 1999
		KYOCERA Document Solutions (Thailand) Corp., Ltd.	—	Aug. 2006
		KYOCERA Display Thailand Co., Ltd.	—	Jan. 2005
	Philippines	KYOCERA Crystal Device Philippines, Inc.	—	Jun. 2006
	Israel	AVX Israel Ltd.	—	May 2003
	Malaysia	TPC Malaysia Sdn Bhd	—	Feb. 2008
		KYOCERA Telecom Equipment (Malaysia) Sdn.Bhd.	—	May. 1998
	Vietnam	KYOCERA Document Technology Vietnam Co., Ltd.	—	Aug. 2013
North America	India	KYOCERA Document Solutions India Private Limited	Guragaon	Jun. 2011
			Mumbai	Jun. 2011
			Gujarat	Sep. 2012
			Pune	Sep. 2012
			Nagpur	Sep. 2012
			New Delhi	Sep. 2012
			Lucknow	Sep. 2012
			Chennai	Sep. 2012
			Bangalore	Sep. 2012
			Emakulam	Sep. 2012
			Hyderabad	Sep. 2012
			Vizag	Sep. 2012
			Kolkata	Sep. 2012
	Bhubaneswar	Sep. 2012		
Guhawati	Sep. 2012			
Ranchi	Sep. 2012			
Canada	KYOCERA Document Solutions Canada, Ltd.	—	Jul. 2008	
U.S.A.	KYOCERA America, Inc.	KYOCERA Industrial Ceramics Corporation	—	Aug. 1997
			Vancouver	Jun. 1998
			Mountain Home	Feb. 1999
			SanDiego	Sep. 1997
			—	Aug. 2000
			—	Nov. 2005
			Conway	Feb. 2008
AVX Corporation	Myrtle Beach	Feb. 2008		

Individual Certification (101 sites)

(as of April 2014)

Region	Company	Office / Plant	Date of registration	
North America	U.S.A.	American Technical Ceramics Corp.	—	Feb. 2008
		AVX Greenville, LLC.	—	Mar. 2010
		KYOCERA Document Solutions America, Inc.	Fairfield	Mar. 2007
			Irvine	Mar. 2007
			Norcross	Mar. 2007
			Wood Dale	Mar. 2007
			New York	Mar. 2007
			Irvine	Mar. 2007
			Miami	Mar. 2007
			Arlington	Mar. 2007
	Memphis	Mar. 2007		
	AVX Tantalum Corporation	—	Feb. 2008	
	KYOCERA Document Solutions Development America, Inc.	—	Jun. 2008	
KYOCERA International, Inc.	—	Aug. 1997		
KYOCERA Solar, Inc.	—	Jul. 2010		
Central and South America	Mexico	KYOCERA Mexicana, S.A. de C.V.	—	Dec. 1998
		Avio Excelente, S. de R.L. de C.V.	—	Feb. 2008
		KYOCERA Document Solutions Mexico, S.A. de C.V.	—	Nov. 2008
	El Salvador	AVX Industries Pte. Ltd.	—	Feb. 2008
Brazil	KYOCERA do Brasil Componentes Industriais Ltda.	—	Apr. 2007	
	KYOCERA Document Solutions Brazil, Ltd.	—	Nov. 2009	
Africa	South Africa	KYOCERA Document Solutions South Africa (Pty) Ltd.	—	Apr. 2008

Region	Company	Office / Plant	Date of registration		
Europe	Austria	KYOCERA Document Solutions Austria GmbH	—	Apr. 2008	
	Belgium	KYOCERA Document Solutions Belgium N.V.	—	Apr. 2004	
			Lanskroun	Feb. 2000	
	Czech	AVX Czech Republic s.r.o.	Uherske	Feb. 2008	
			—	Mar. 2009	
	Denmark	KYOCERA Document Solutions Danmark A/S	—	Apr. 2008	
			—	Mar. 1996	
			—	Mar. 1996	
			—	Mar. 1996	
	Finland	KYOCERA Document Solutions Finland OY	—	Apr. 2008	
	Norway	KYOCERA Document Solutions Norge NUF	—	Apr. 2008	
	Sweden	KYOCERA Document Solutions Nordic AB	—	Apr. 2008	
	France	KYOCERA Document Solutions France S.A.S.	—	Feb. 2008	
			—	Apr. 2008	
	Germany	ELCO Europe GmbH	—	Feb. 2008	
			—	Apr. 2008	
			—	Jul. 2004	
	Italy	KYOCERA Document Solutions Italia S.p.A.	—	Apr. 2008	
			—	Apr. 2008	
	Netherlands	KYOCERA Document Solutions Nederland B.V.	Hoeksteen	Mar. 2007	
			Zurich	Apr. 2008	
	Portugal	KYOCERA Document Solutions Portugal Lda.	—	Apr. 2008	
	Spain	KYOCERA Document Solutions Espana S.A.	—	Apr. 2008	
	U.K.	KYOCERA Document Solutions (U.K.) Ltd.	—	Apr. 2008	
			—	Aug. 2000	
	Oceania	New Zealand	KYOCERA Document Solutions New Zealand Ltd.	—	Oct. 2007
		Australia	KYOCERA Document Solutions Australia Pty. Ltd.	—	Jun. 2006

OHSAS 18001 Certification Status

Integrated Certification (135 sites)

(as of April 2014)

Region	Company					Date of registration	
Japan	KYOCERA Corporation	Headquarters	Hokkaido Kitami Plant	Fukushima Tanagura Plant	Chiba Sakura Office	Tokyo Yaesu Office	Oct. 2005 (Registration No.:C05J0006)
		Tokyo Harajuku Office	Yokohama Office	Nagano Okaya Plant	Mie Ise Plant	Shiga Gamo Plant	
		Shiga Yohkaichi Plant	Shiga Yasu Plant	Kyoto Fushimi Office	R&D Center, Keihanna	Osaka Daito Office	
		Kagoshima Sendai Plant	Kagoshima Kokubu Plant	R&D Center, Kagoshima	Kagoshima Hayato Plant	Sapporo Sales Office	
		Tohoku Sales Office	Nagaoka Sales Office	Takasaki Sales Office	Utsunomiya Sales Office	Okegawa Sales Office	
		Omiya Sales Office	Tachikawa Sales Office	Kanto Logistics Center	Atsugi Sales Office	Kanazawa Sales Office	
		Matsumoto Sales Office	Hamamatsu Sales Office	Nagoya Sales Office	Mikawa Sales Office	The Inamori Library	
		Kyocera Keiaikan	Osaka Sales Office	Himeji Sales Office	Okayama Sales Office	Hiroshima Sales Office	
		Kyushu Sales Office	Okinawa Sales Office	CV Ginza Store	CV Kyoto Store	CV Osaka Umeda Store	
		CV Kobe Sannomiya Store					
	KYOCERA Connector Products Corporation	Headquarters	Okaya Plant	Osaka Sales Office	Nagoya Sales Office	Omiya Sales Office	
		Tachikawa Sales Office	Matsumoto Sales Office				
KYOCERA OPTEC Co., Ltd.	Headquarters	Chigase Plant	Tokyo Sales Office	Kansai Sales Office			
KYOCERA Document Solutions Inc.	Headquarters	Hirakata Plant	Tamaki Plant	Tokyo R&D Center			
KYOCERA Document Solutions Japan Inc.	Headquarters						
KYOCERA Chemical Corp.	Headquarters	Kansai Branch	Kyushu Branch	Kawasaki Plant	Kohriyama Plant		
	Moka Plant						
KYOCERA SLC Technologies Corp.	Headquarters	Shiga Yasu Plant	Kyoto Ayabe Plant	Kagoshima Sendai Plant	Higashi Nihon Sales Office		
	Kyushu Sales Office						
KYOCERA Crystal Device Corporation	Headquarters	Hokkaido Mikasa Plant	Nagano Okaya Plant	Shiga Yohkaichi Plant			
KYOCERA Medical Corporation	Headquarters	Tokyo Branch	Kobe Plant	Shiga Gamo Plant	Shiga Yohkaichi Plant		
	Shiga Yasu Plant	Research Center	Kobe Product Control Center	Sapporo Sales Office	Tohoku Sales Office		
	Omiya Sales Office	Nagoya Sales Office	Kyoto Sales Office	Okayama Sales Office	Hiroshima Sales Office		
	Kyushu Sales Office						
KYOCERA Communication Systems Co., Ltd.	Headquarters	Tokyo Branch	Tokyo 1st Data Center (2 sites)		Tokyo 2nd Data Center		
	Tokyo 3rd Data Center	Takanawa Branch	Shiga Office	Kyoto Karasuma Office	Osaka Office		
	Osaka ICT Branch	Fukuoka Office	Sendai Office	Kokubu Office	Sapporo Sales Office		
	Sendai Sales Office	Nagoya Sales Office	Kanazawa Sales Office	Hiroshima Sales Office	Takamatsu Sales Office		
	Kagoshima Sales Office						
KYOCERA Solar Corp.	Headquarters	Tokyo Branch	Tohoku Sales Office	Nagoya Sales Office	Osaka Sales Office		
	Okayama Sales Office	Hiroshima Sales Office	Kyushu Sales Office	Sakura Office	Shiga Yohkaichi Office		
	Kagoshima Sales Office	KYOCERA Solar FC Lake Town		KYOCERA Solar FC Itami Koya			

※ The above 128 offices and plants are jointly ISO 14001 certified under the Kyocera Group Integrated Environment & Safety Management System.

Individual Certification (13 sites)

(as of April 2014)

Region	Company	Office/Plant	Date of registration	
Asia	China	Shanghai KYOCERA Electronics Co., Ltd.	Nov. 2006	
		Dongguan Shilong KYOCERA Co.,Ltd.	Jan. 2009	
		KYOCERA Connector Products (Dongguan) Co., Ltd.	Jan. 2009	
		KYOCERA Document Technology (Dongguan) Co., Ltd.	Jan. 2009	
		KYOCERA Precision Tools (Zhuhai) Co., Ltd.	Mar. 2014	
North America	U.S.A.	KYOCERA America, Inc.	Dec. 2013	
		KYOCERA Industrial Ceramics Corporation	Mountain Home	Nov. 2013
			Vancouver	Jan. 2014
	KYOCERA Precision Tools, Inc.	–	Dec. 2013	
KYOCERA Communications Inc.	–	Nov. 2012		
Mexico	KYOCERA Mexicana, S.A. de C.V.	–	Dec. 2013	
Central and South America	El Salvador	AVX Industries Pte, Ltd.	Oct. 2011	
Europe	Czech	KYOCERA Solar Europe s.r.o.	Mar. 2009	

Editorial Policy

This CSR report is published to report on the Kyocera Group's CSR activities in keeping with the concept of ISO 26000, International Standard concerning social responsibilities. Information contained in this report is disclosed in consideration of opinions and views received from stakeholders, and the degree of importance placed on the above activities by the Kyocera Group.

Reporting Period

Information disclosed focuses on content from FY2014 (April 1, 2013 to March 31, 2014).

Scope of the Report

Kyocera Corporation and consolidated subsidiaries

In this report, "Kyocera" refers to Kyocera Corporation as a separate entity. The environmental data shown here are for production sites. Whenever the scope differs, it is so specified.

Guideline References

GRI* "Sustainability Reporting Guidelines, Version 3.1"

* GRI: Global Reporting Initiative is an international organization established in 1997 to draft a sustainability report framework for use by organizations worldwide.

Accuracy of Information

To ensure the accuracy of disclosed information, the information presented here is disclosed after being cross-checked by multiple divisions, including the division providing the information, the Editorial Section, and the Corporate Communications Division.

GRI and ISO 26000 Comparison Tables

The Kyocera Group strives to report in conformity to international standards and refers to core subjects of Sustainability Reporting Guidelines Version 3.1 of GRI and ISO 26000: 2010.

GRI Guideline

Item	Indicator	References
1. Strategy and Analysis		
1.1	Statement from the most senior decision-maker of the organization (e.g., CEO, chair, or equivalent senior position) about the relevance of sustainability to the organization and its strategy	→ Top Management Message
1.2	Description of key impacts, risks, and opportunities	→ Top Management Message → Form 20-F 
2. Organizational Profile		
2.1	Name of the organization	→ Corporate Summary 
2.2	Primary brands, products, and/or services	→ Business Segments 
2.3	Operational structure of the organization, including main divisions, operating companies, subsidiaries, and joint ventures	→ Business Development 
2.4	Location of organization's headquarters	→ Corporate Summary 
2.5	Number of countries where the organization operates, and names of countries with either major operations or that are specifically relevant to the sustainability issues covered in the report	→ Business Development  → Global Network 
2.6	Nature of ownership and legal form	→ Corporate Summary  → Form 20-F 
2.7	Markets served (including geographic breakdown, sectors served, and types of customers/beneficiaries)	→ Corporate Summary 
2.8	Scale of the reporting organization, including:	→ Corporate Summary 
2.9	Significant changes during the reporting period regarding size, structure, or ownership including:	→ Form 20-F 
2.10	Awards received in the reporting period	→ Main Feedback on Sustainable Management → Approaches to Raising Quality and Customer Satisfaction Levels







3. Report Parameters		
Report Profile		
3.1	Reporting period (e.g., fiscal/calendar year) for information provided	→ Editorial Policy
3.2	Date of most recent previous report (if any)	June, 2013
3.3	Reporting cycle (annual, biennial, etc)	Annual
3.4	Contact point for questions regarding the report or its contents	→ Support / Contact 
Report Scope and Boundary		
3.5	Process for defining report content, including:	→ Editorial Policy
3.6	Boundary of the report (e.g., countries, divisions, subsidiaries, leased facilities, joint ventures, suppliers). See GRI Boundary Protocol for further guidance	→ Editorial Policy
3.7	State any specific limitations on the scope or boundary of the report	→ Editorial Policy
3.8	Basis for reporting on joint ventures, subsidiaries, leased facilities, outsourced operations, and other entities that can significantly affect comparability from period to period and/or between organizations	→ Form 20-F 
3.9	Data measurement techniques and the bases of calculations, including assumptions and techniques underlying estimations applied to the compilation of the Indicators and other information in the report	→ Environmental Accounting → Green Factories
3.10	Explanation of the effect of any re-statements of information provided in earlier reports, and the reasons for such re-statement (e.g., mergers/ acquisitions, change of base years/periods, nature of business, measurement methods)	→ Form 20-F 
3.11	Significant changes from previous reporting periods in the scope, boundary, or measurement methods applied in the report	-



GRI Content Index		
3.12	Table identifying the location of the Standard Disclosures in the report	GRI Guideline Comparison Table
Assurance		
3.13	Policy and current practice with regard to seeking external assurance for the report. If not included in the assurance report accompanying the sustainability report, explain the scope and basis of any external assurance provided. Also explain the relationship between the reporting organization and the assurance provider(s)	-
4. Governance, Commitments, and Engagement		
Governance		
4.1	Governance structure of the organization, including committees under the highest governance body responsible for specific tasks, such as setting strategy or organizational oversight	→ Corporate Governance
4.2	Indicate whether the Chair of the highest governance body is also an executive officer (and, if so, their function within the organization's management and the reasons for this arrangement)	→ Corporate Governance
4.3	For organizations that have a unitary board structure, state the number and gender of members of the highest governance body that are independent and/or non-executive members	→ Corporate Governance
4.4	Mechanisms for shareholders and employees to provide recommendations or direction to the highest governance body	→ Corporate Governance
4.5	Linkage between compensation for members of the highest governance body, senior managers, and executives (including departure arrangements), and the organization's performance (including social and environmental performance)	→ Corporate Governance

4.6	Processes in place for the highest governance body to ensure conflicts of interest are avoided.	→ Corporate Governance
4.7	Process for determining the composition, qualifications, and expertise of the members of the highest governance body and its committees, including any consideration of gender and other indicators of diversity.	→ Corporate Governance
4.8	Internally developed statements of mission or values, codes of conduct, and principles relevant to economic, environmental, and social performance and the status of their implementation	→ Kyocera Group Corporate Social Responsibility (CSR) → Corporate Governance
4.9	Procedures of the highest governance body for overseeing the organization's identification and management of economic, environmental, and social performance, including relevant risks and opportunities, and adherence or compliance with internationally agreed standards, codes of conduct, and principles	→ Kyocera Group Corporate Social Responsibility (CSR) → Corporate Governance
4.10	Processes for evaluating the highest governance body's own performance, particularly with respect to economic, environmental, and social performance	→ Kyocera Group Corporate Social Responsibility (CSR) → Corporate Governance
Commitments to External Initiatives		
4.11	Explanation of whether and how the precautionary approach or principle is addressed by the organization	→ Corporate Governance → Risk Management and Compliance → Environmental Risk Management
4.12	Externally developed economic, environmental, and social charters, principles, or other initiatives to which the organization subscribes or endorses	→ Participation in International Initiatives
4.13	Memberships in associations (such as industry associations) and/or national/international advocacy organizations in which the organization:	Keidanren (Japan Business Federation), JEITA (Japan Electronics and Information Technology Industries Association) etc

Stakeholder Engagement		
4.14	List of stakeholder groups engaged by the organization	→ Kyocera Group Corporate Social Responsibility (CSR)
4.15	Basis for identification and selection of stakeholders with whom to engage	→ Kyocera Group Corporate Social Responsibility (CSR)
4.16	Approaches to stakeholder engagement, including frequency of engagement by type and by stakeholder group	→ Respect for Human Rights / Optimal Work Environment → Fair Business Activities → Customer Concerns → Social Contribution Activities
4.17	Key topics and concerns that have been raised through stakeholder engagement, and how the organization has responded to those key topics and concerns, including through its reporting	→ Respect for Human Rights / Optimal Work Environment → Fair Business Activities → Customer Concerns → Social Contribution Activities

Management Approach and Performance Indicators

Item	Performance Index: Core (●) / Add (○)	References
Economic		
■ Disclosure on Management Approach		
Goals and Performance. Organization-wide goals regarding performance relevant to the Economic Aspects.		→ Financial Results  → Form 20-F 
Policy Brief, organization-wide policy (or policies) that defines the organization's overall commitment relating to the Economic Aspects listed above, or state where this can be found in the public domain (e.g., web link).		→ Financial Results  → Form 20-F 
Additional Contextual Information Additional relevant information required to understand organizational performance, such as: <ul style="list-style-type: none"> ● Key successes and shortcomings; ● Major organizational risks and opportunities; ● Major changes in the reporting period to systems or structures to improve performance; and ● Key strategies for implementing policies or achieving performance. 		→ Financial Results  → Form 20-F 

■ Economic Performance Indicators		
● EC1	Direct economic value generated and distributed, including revenues, operating costs, employee compensation, donations and other community investments, retained earnings, and payments to capital providers and governments	→ Form 20-F 
● EC2	Financial implications and other risks and opportunities for the organization's activities due to climate change	→ Form 20-F 
● EC3	Coverage of the organization's defined benefit plan obligations	-
● EC4	Significant financial assistance received from government	-
■ Market Presence		
○ EC5	Range of ratios of standard entry level wage by gender compared to local minimum wage at significant locations of operation	-
● EC6	Policy, practices, and proportion of spending on locally-based suppliers at significant locations of operation	→ Promotion of Green Procurement → Policy and Systems Related to Purchasing Activities → Reporting on Conflict Minerals
● EC7	Procedures for local hiring and proportion of senior management hired from the local community at locations of significant operation	→ Respect for Diversity / Work-Life Balance (Adapting to Globalization)
■ Indirect Economic Impacts		
● EC8	Development and impact of infrastructure investments and services provided primarily for public benefit through commercial, in-kind, or pro bono engagement	→ Social Contribution Activities
○ EC9	Understanding and describing significant indirect economic impacts, including the extent of impacts	-

Environmental		
■ Disclosure on Management Approach		
Goals and Performance Organization-wide goals regarding performance relevant to the Environmental Aspects.		→ Goals and Results of CSR Activities → Green Products → Green Factories → Green Communication
Policy Brief, organization-wide policy (or policies) that defines the organization's overall commitment related to the Environmental Aspects listed above or state where this can be found in the public domain (e.g., web link).		→ Kyocera Group Environmental Management
Organizational responsibility The most senior position with operational responsibility for Environmental Aspects or explain how operational responsibility is divided at the senior level for these Aspects.		→ Environmental Management Promotion System
Training and awareness Procedures related to training and raising awareness in relation to the Environmental Aspects.		→ Environmental Education
Monitoring and Follow-Up Procedures related to monitoring and corrective and preventive actions, including those related to the supply chain.		→ Environmental Audit → Promotion of Green Procurement → Thorough Legal Compliance (Legal Audit System)
Additional Contextual Information Additional relevant information required to understand organizational performance, such as: <ul style="list-style-type: none"> • Key successes and shortcomings; • Major organizational environmental risks and opportunities related to issues; • Major changes in the reporting period to systems or structures to improve performance; and • Key strategies and procedures for implementing policies or achieving goals. 		→ Environmental Activities
■ Materials		
● EN1	Materials used by weight or volume	-
● EN2	Percentage of materials used that are recycled input materials	→ Environmentally Friendly Products

■ Energy		
● EN3	Direct energy consumption by primary energy source	<input type="checkbox"/> Environmental Accounting <input type="checkbox"/> Energy Conservation and Prevention of Climate Change
● EN4	Indirect energy consumption by primary source	<input type="checkbox"/> Environmental Accounting <input type="checkbox"/> Energy Conservation and Prevention of Climate Change
○ EN5	Energy saved due to conservation and efficiency improvements	<input type="checkbox"/> Environmental Accounting <input type="checkbox"/> Energy Conservation and Prevention of Climate Change
○ EN6	Initiatives to provide energy-efficient or renewable energy based products and services, and reductions in energy requirements as a result of these initiatives	<input type="checkbox"/> Development of Environmentally Friendly Products <input type="checkbox"/> Energy Conservation and Prevention of Climate Change
○ EN7	Initiatives to reduce indirect energy consumption and reductions achieved	<input type="checkbox"/> Green Factories <input type="checkbox"/> Energy Conservation and Prevention of Climate Change
■ Water		
● EN8	Total water withdrawal by source	-
○ EN9	Water sources significantly affected by withdrawal of water	-
○ EN10	Percentage and total volume of water recycled and reused	<input type="checkbox"/> Effective Use of Water Resources
■ Biodiversity		
● EN11	Location and size of land owned, leased, managed in, or adjacent to, protected areas and areas of high biodiversity value outside protected areas	<input type="checkbox"/> Activities Related to the Conservation of Biodiversity
● EN12	Description of significant impacts of activities, products, and services on biodiversity in protected areas and areas of high biodiversity value outside protected areas	<input type="checkbox"/> Activities Related to the Conservation of Biodiversity
○ EN13	Habitats protected or restored	<input type="checkbox"/> Activities Related to the Conservation of Biodiversity
○ EN14	Strategies, current actions, and future plans for managing impacts on biodiversity	<input type="checkbox"/> Kyocera Group Environmental Management <input type="checkbox"/> Green Communication

○ EN15	Number of IUCN Red List species and national conservation list species with habitats in areas affected by operations, by level of extinction risk	-
■ Emissions, Effluents, and Waste		
● EN16	Total direct and indirect greenhouse gas emissions by weight	→ Energy Conservation and Prevention of Climate Change
● EN17	Other relevant indirect greenhouse gas emissions by weight	→ Energy Conservation and Prevention of Climate Change
○ EN18	Initiatives to reduce greenhouse gas emissions and reductions achieved	→ Energy Conservation and Prevention of Climate Change
● EN19	Emissions of ozone-depleting substances by weight	Complete elimination
● EN20	NO, SO, and other significant air emissions by type and weight	→ Chemical Substances Management → Kyocera Group's Environmental Impact at Each Site
● EN21	Total water discharge by quality and destination	→ Reducing Water Consumption and Improving the Water Recycling Rate → Kyocera Group's Environmental Impact at Each Site
● EN22	Total weight of waste by type and disposal method	→ Waste Reduction and Recycling Measures → Kyocera Group's Environmental Impact at Each Site
● EN23	Total number and volume of significant spills	→ Environmental Risk Management → Green Factories → Kyocera Group's Environmental Impact at Each Site
○ EN24	Weight of transported, imported, exported, or treated waste deemed hazardous under the terms of the Basel Convention Annex I, II, III, and VIII, and percentage of transported waste shipped internationally	-
○ EN25	Identity, size, protected status, and biodiversity value of water bodies and related habitats significantly affected by the reporting organization's discharges of water and runoff	-

■ Products and Services		
○ EN26	Initiatives to mitigate environmental impacts of products and services, and extent of impact mitigation	<ul style="list-style-type: none"> ➔ Green Products ➔ Environmentally Friendly Products
○ EN27	Percentage of products sold and their packaging materials that are reclaimed by category	<ul style="list-style-type: none"> ➔ Environmentally Friendly Products
■ Compliance		
● EN28	Monetary value of significant fines and total number of non-monetary sanctions for non-compliance with environmental laws and regulations	<ul style="list-style-type: none"> ➔ Environmental Risk Management (Environmental Regulations Compliance Status)
■ Transport		
○ EN29	Significant environmental impacts of transporting products and other goods and materials used for the organization's operations, and transporting members of the workforce	<ul style="list-style-type: none"> ➔ Efforts to Reduce CO₂ Emission Associated with Freight Transport
■ Overall		
○ EN30	Total environmental protection expenditures and investments by type	<ul style="list-style-type: none"> ➔ Environmental Accounting
Social		
Labor Practices and Decent Work		
■ Disclosure on Management Approach		
Goals and Performance Organization-wide goals regarding performance relevant to the Labor Aspects, indicating their linkage to the internationally recognized universal standards.		<ul style="list-style-type: none"> ➔ Goals and Results of CSR Activities ➔ Advancing Kyocera Philosophy Education ➔ Respect for Human Rights and Diversity ➔ Cultivation of Human Resources ➔ Building a Safe & Secure Work Environment
Policy Brief, organization-wide policy (or policies) that defines the organization's overall commitment related to the Labor Aspects, or state where this can be found in the public domain (e.g., web link). Also reference their linkage to the international standards indicated above.		<ul style="list-style-type: none"> ➔ Kyocera Group CSR Guidelines ➔ Respect for Human Rights and Diversity ➔ Occupational Health & Safety Policy

<p>Organizational responsibility The most senior position with operational responsibility for Labor Aspects or explain how operational responsibility is divided at the senior level for these Aspects.</p>	<ul style="list-style-type: none"> → Advancing Kyocera Philosophy Education → Respect for Human Rights and Diversity → Environmental Management Promotion System 	
<p>Training and awareness Procedures related to training and raising awareness in relation to the Labor Aspects. Include information on who participates in diversity, equal opportunities and gender sensitization training (e.g., highest governance bodies, senior management), and the topics addressed by training and any informal awareness raising.</p>	<ul style="list-style-type: none"> → Advancing Kyocera Philosophy Education → Respect for Human Rights and Diversity → Cultivation of Human Resources → Building a Safe & Secure Work Environment 	
<p>Monitoring and Follow-Up Procedures related to monitoring and corrective and preventive actions, including those related to the supply chain.</p>	<ul style="list-style-type: none"> → Advancing Kyocera Philosophy Education → Thorough Legal Compliance (Legal Audit System) → Respect for Human Rights and Diversity → Environmental Audit → CSR Deployment in the Supply Chain 	
<p>Additional Contextual Information Additional relevant information required to understand organizational performance, such as:</p> <ul style="list-style-type: none"> ● Key successes and shortcomings; ● Major organizational risks and opportunities; ● Major changes in the reporting period to systems or structures to improve performance; and ● Key strategies and procedures for implementing policies or achieving goals. ● A description of the legal and socio-economic environment that provides opportunities for, and barriers to, gender equity in the workforce, including but not limited to women's workforce participation rates, their participation at highest governance level, and equal remuneration. 	<ul style="list-style-type: none"> → Advancing Kyocera Philosophy Education → Respect for Human Rights and Diversity → Cultivation of Human Resources → Building a Safe & Secure Work Environment 	
<p>■ Employment</p>		
<p>● LA1</p>	<p>Total workforce by employment type, employment contract, and region, broken down by gender</p>	<p>-</p>

● LA2	Total number and rate of new employee hires and employee turnover by age group, gender, and region	→ Careers 
○ LA3	Benefits provided to full-time employees that are not provided to temporary or part-time employees, by significant locations of operations	-
● LA15	Return to work and retention rates after parental leave, by gender	-
■ Labor/Management Relations		
● LA4	Percentage of employees covered by collective bargaining agreements	-
● LA5	Minimum notice period(s) regarding operational changes, including whether it is specified in collective agreements	-
■ Occupational Health and Safety		
○ LA6	Percentage of total workforce represented in formal joint management- worker health and safety committees that help monitor and advise on occupational health and safety programs	→ Approaches to Stimulating Communication (Labor and Management Exchange Conference)
● LA7	Rates of injury, occupational diseases, lost days, and absenteeism, and total number of work-related fatalities, by region and by gender	→ Approaches to Occupational Safety and Health / Fire and Disaster Prevention (Kyocera Group (Japan) Safety Record)
● LA8	Education, training, counseling, prevention, and risk-control programs in place to assist workforce members, their families, or community members regarding serious diseases	→ Approaches to Promotion of Health
● LA9	Health and safety topics covered in formal agreements with trade unions	→ Approaches to Promotion of Health
■ Training and Education		
● LA10	Average hours of training per year per employee by gender, and by employee category	→ Advancing Kyocera Philosophy Education → Cultivation of Human Resources

○ LA11	Programs for skills management and lifelong learning that support the continued employability of employees and assist them in managing career endings	→ Philosophy Education System
○ LA12	Percentage of employees receiving regular performance and career development reviews, by gender	-
■ Diversity and Equal Opportunity		
● LA13	Composition of governance bodies and breakdown of employees per employee category according to gender, age group, minority group membership, and other indicators of diversity	→ Respect for Diversity / Balance of Work and Life (Adapting to Globalization)
● LA14	Ratio of basic salary and remuneration of women to men by employee category, by significant locations of operation	No discrimination with regard to male and female compensation within the same category
Human Rights		
■ Disclosure on Management Approach		
Goals and Performance Organization-wide goals regarding performance relevant to the human rights Aspects, indicating their linkage to the international declarations and standards listed in the introduction.		→ Goals and Results of CSR Activities → Respect for Human Rights and Diversity
Policy Brief, organization-wide policy or policies that define the organization's overall commitment to the human rights Aspects.		→ Kyocera Group CSR Guidelines → Respect for Human Rights and Diversity → Policy and Systems Related to Purchasing Activities
Organizational responsibility The most senior position with operational responsibility for human rights Aspects, or an explanation of how operational responsibility is divided at senior level for these Aspects.		→ Respect for Human Rights and Diversity → Supply Chain Management
Procedures related to training and raising awareness in relation to the human rights Aspects,		→ Advancing Kyocera Philosophy Education → Respect for Human Rights and Diversity

Monitoring, Follow-Up AND REMEDIATION Procedures related to monitoring and corrective and preventive actions, including those related to the supply chain.		<ul style="list-style-type: none"> ➔ Advancing Kyocera Philosophy Education ➔ Respect for Human Rights and Diversity ➔ Thorough Legal Compliance (Legal Audit System) ➔ Policy and Systems Related to Purchasing Activities
Additional Contextual Information Additional relevant information required to understand organizational performance, such as: <ul style="list-style-type: none"> ● Key successes and shortcomings; ● Major organizational risks and opportunities; ● Major changes in the reporting period to systems or structures to improve performance; and ● Key strategies and procedures for implementing policies or achieving goals. 		<ul style="list-style-type: none"> ➔ Respect for Human Rights and Diversity ➔ Supply Chain Management
■ Investment and Procurement Practices		
● HR1	Percentage and total number of significant investment agreements and contracts that include clauses incorporating human rights concerns, or that have undergone human rights screening	-
● HR2	Percentage of significant suppliers, contractors, and other business partners that have undergone human rights screening, and actions taken	➔ CSR Deployment in the Supply Chain
○ HR3	Total hours of employee training on policies and procedures concerning aspects of human rights that are relevant to operations, including the percentage of employees trained	<ul style="list-style-type: none"> ➔ Advancing Kyocera Philosophy Education ➔ Respect for Human Rights and Diversity
■ Non-Discrimination		
● HR4	Total number of incidents of discrimination and corrective actions taken	-

■ Freedom of Association and Collective Bargaining		
● HR5	Operations and significant suppliers identified in which the right to exercise freedom of association and collective bargaining may be violated or at significant risk, and actions taken to support these rights	<input checked="" type="checkbox"/> Respect for Human Rights and Diversity <input checked="" type="checkbox"/> CSR Deployment in the Supply Chain
■ Child Labor		
● HR6	Operations and significant suppliers identified as having significant risk for incidents of child labor, and measures taken to contribute to the effective abolition of child labor	<input checked="" type="checkbox"/> Respect for Human Rights and Diversity <input checked="" type="checkbox"/> CSR Deployment in the Supply Chain
■ Forced and Compulsory Labor		
● HR7	Operations and significant suppliers identified as having significant risk for incidents of forced or compulsory labor, and measures to contribute to the elimination of all forms of forced or compulsory labor	<input checked="" type="checkbox"/> Respect for Human Rights and Diversity <input checked="" type="checkbox"/> CSR Deployment in the Supply Chain
■ Security Practices		
○ HR8	Percentage of security personnel trained in the organization's policies or procedures concerning aspects of human rights that are relevant to operations	-
■ Indigenous Rights		
○ HR9	Total number of incidents of violations involving rights of indigenous people and actions taken	-
○ HR10	Percentage and total number of operations that have been subject to human rights reviews and/or impact assessments	-
○ HR11	Number of grievances related to human rights filed, addressed and resolved through formal grievance mechanisms	-

Society		
■ Disclosure on Management Approach		
Goals and Performance Organization-wide goals regarding performance relevant to the Aspects indicated above.		<ul style="list-style-type: none"> → Goals and Results of CSR Activities → Corporate Governance → Risk Management and Compliance
Policy Brief, organization-wide policy (or policies) that define the organization's overall commitment relating to the Society Aspects or state where this can be found in the public domain (e.g., web link).		<ul style="list-style-type: none"> → Kyocera Group CSR Guidelines → Corporate Governance and Internal Control Systems → Risk Management and Compliance
Organizational responsibility The most senior position with operational responsibility for Society Aspects or explain how operational responsibility is divided at the senior level for these Aspects.		<ul style="list-style-type: none"> → Corporate Governance and Internal Control Systems
Training and awareness Procedures related to training and raising awareness in relation to the Society Aspects.		<ul style="list-style-type: none"> → Advancing Kyocera Philosophy Education → Cultivation of Human Resources → Thorough Legal Compliance
Monitoring and Follow-Up Procedures related to monitoring and corrective and preventive actions, including those related to the supply chain.		<ul style="list-style-type: none"> → Thorough Legal Compliance (Legal Audit System) → CSR Deployment in the Supply Chain
Additional Contextual Information Additional relevant information required to understand organizational performance, such as: <ul style="list-style-type: none"> ● Key successes and shortcomings; ● Major organizational risks and opportunities; ● Major changes in the reporting period to systems or structures to improve performance; and ● Key strategies and procedures for implementing policies or achieving goals. 		<ul style="list-style-type: none"> → Corporate Governance → Risk Management and Compliance
■ Local Communities		
● SO1	Percentage of operations with implemented local community engagement, impact assessments, and development programs	<ul style="list-style-type: none"> → Green Communication → Social Contribution Activities

● SO9	Operations with significant potential or actual negative impacts on local communities	→ Environmental Risk Management
● SO10	Prevention and mitigation measures implemented in operations with significant potential or actual negative impacts on local communities	→ Environmental Risk Management
■ Corruption		
● SO2	Percentage and total number of business units analyzed for risks related to corruption	→ Internal Control Audits of the Kyocera Group → Thorough Legal Compliance (Legal Audit System)
● SO3	Percentage of employees trained in organization's anti-corruption policies and procedures	→ Advancing Kyocera Philosophy Education → Thorough Legal Compliance
● SO4	Actions taken in response to incidents of corruption	-
■ Public Policy		
● SO5	Public policy positions and participation in public policy development and lobbying	-
○ SO6	Total value of financial and in-kind contributions to political parties, politicians, and related institutions by country	→ Thorough Legal Compliance (Ensuring Transparency in Political Donations)
■ Anti-Competitive Behavior		
● SO7	Total number of legal actions for anti-competitive behavior, anti-trust, and monopoly practices and their outcomes	-
■ Compliance		
● SO8	Monetary value of significant fines and total number of non-monetary sanctions for non-compliance with laws and regulations	-
Product Responsibility		
■ Disclosure on Management Approach		
Goals and Performance Organization-wide goals regarding performance relevant to the Product Responsibility Aspects.		→ Goals and Results of CSR Activities → Approaches to Raising Quality and Customer Satisfaction Levels

<p>Policy Brief, organization-wide policy (or policies) that defines the organization's overall commitment to the Product Responsibility Aspects, or state where this can be found in the public domain (e.g., web link).</p>	<ul style="list-style-type: none"> ➔ Corporate Motto / Management Rationale (Methods of Management) ➔ Efforts to Improve Product Quality ➔ Efforts to Ensure Product Safety 	
<p>Organizational responsibility The most senior position with operational responsibility for Product Responsibility Aspects, or explain how operational responsibility is divided at the senior level for Product Responsibility Aspects.</p>	<ul style="list-style-type: none"> ➔ Efforts to Improve Product Quality (Quality Management Systems) 	
<p>Training and awareness Procedures related to training and raising awareness in relation to the Product Responsibility Aspects.</p>	<ul style="list-style-type: none"> ➔ Efforts to Improve Product Quality (Quality Management Systems) 	
<p>Monitoring and Follow-Up Procedures related to monitoring and corrective and preventive actions, including those related to the supply chain.</p>	<ul style="list-style-type: none"> ➔ Promotion of Green Procurement ➔ Thorough Legal Compliance (Legal Audit System) ➔ CSR Deployment in the Supply Chain ➔ Efforts to Improve Product Quality (Quality Management Systems) 	
<p>Additional Contextual Information Additional relevant information required to understand organizational performance, such as:</p> <ul style="list-style-type: none"> ● Key successes and shortcomings; ● Major organizational risks and opportunities; ● Major changes in the reporting period to systems or structures to improve performance; and ● Key strategies and procedures for implementing policies or achieving goals. 	<ul style="list-style-type: none"> ➔ Approaches to Raising Quality and Customer Satisfaction Levels 	
<p>■ Customer Health and Safety</p>		
<p>● PR1</p>	<p>Life cycle stages in which health and safety impacts of products and services are assessed for improvement, and percentage of significant products and services categories subject to such procedures</p>	<ul style="list-style-type: none"> ➔ Efforts to Ensure Product Safety
<p>○ PR2</p>	<p>Total number of incidents of non-compliance with regulations and voluntary codes concerning health and safety impacts of products and services during their life cycle, by type of outcomes</p>	<p>-</p>

■ Product and Service Labeling		
● PR3	Type of product and service information required by procedures, and percentage of significant products and services subject to such information requirements	→ Development of Environmentally Friendly Products → Promotion of Green Procurement
○ PR4	Total number of incidents of non-compliance with regulations and voluntary codes concerning product and service information and labeling, by type of outcomes	-
○ PR5	Practices related to customer satisfaction, including results of surveys measuring customer satisfaction	→ Approaches to Raising Customer Satisfaction Levels
■ Marketing Communications		
● PR6	Programs for adherence to laws, standards, and voluntary codes related to marketing communications, including advertising, promotion, and sponsorship	→ Thorough Legal Compliance (Appropriate Information Disclosure)
○ PR7	Total number of incidents of non-compliance with regulations and voluntary codes concerning marketing communications, including advertising, promotion, and sponsorship by type of outcomes	-
■ Customer Privacy		
○ PR8	Total number of substantiated complaints regarding breaches of customer privacy and losses of customer data	-
■ Compliance		
● PR9	Monetary value of significant fines for non-compliance with laws and regulations concerning the provision and use of products and services	→ Information 

ISO26000

ISO26000 Core Subjects	Issues	References
Organizational Governance	-	<ul style="list-style-type: none"> ➔ Top Management Message ➔ Kyocera Group Corporate Social Responsibility (CSR) ➔ Corporate Governance
Human Rights	<ol style="list-style-type: none"> 1. Due diligence 2. Human rights risk situations 3. Avoidance of complicity 4. Resolving grievances 5. Discrimination and vulnerable groups 6. Civil and political rights 7. Economic, social and cultural rights 8. Fundamental principles and rights at work 	<ul style="list-style-type: none"> ➔ Respect for Human Rights and Diversity ➔ Risk Management and Compliance ➔ Supply Chain Management
Labour Practices	<ol style="list-style-type: none"> 1. Employment and employment relationships 2. Conditions of work and social protection 3. Social dialogue 4. Health and safety at work 5. Human development and training in the workplace 	<ul style="list-style-type: none"> ➔ Respect for Human Rights and Diversity ➔ Cultivation of Human Resources ➔ Building a Safe & Secure Work Environment
The Environment	<ol style="list-style-type: none"> 1. Prevention of pollution 2. Sustainable resource use 3. Climate change mitigation and adaptation 4. Protection of the environment, biodiversity and restoration of natural habitats 	<ul style="list-style-type: none"> ➔ Kyocera Group Environmental Management ➔ Green Management ➔ Green Products ➔ Green Factories ➔ Green Communication

<p>Fair Operating Practices</p>	<ol style="list-style-type: none"> 1. Anti-corruption 2. Responsible political involvement 3. Fair competition 4. Promoting social responsibility in the value chain 5. Respect for property rights 	<ul style="list-style-type: none"> ➔ Promotion of Green Procurement ➔ Risk Management and Compliance ➔ Supply Chain Management
<p>Consumer Issues</p>	<ol style="list-style-type: none"> 1. Fair marketing, factual and unbiased information and fair contractual practices 2. Protecting consumers' health and safety 3. Sustainable consumption 4. Consumer service, support, and complaint and dispute resolution 5. Consumer data protection and privacy 6. Access to essential services 7. Education and awareness 	<ul style="list-style-type: none"> ➔ Promotion of Green Procurement ➔ Risk Management and Compliance ➔ Supply Chain Management ➔ Customer Concerns
<p>Community Involvement and Development</p>	<ol style="list-style-type: none"> 1. Community involvement 2. Education and culture 3. Employment creation and skills development 4. Technology development and access 5. Wealth and income creation 6. Health 7. Social investment 	<ul style="list-style-type: none"> ➔ Green Communication ➔ Social Contribution Activities



KYOCERA Corporation

About the cover design



U-Shaped Kelcima

Kyocera was established in 1959 as a small suburban workshop where 28 young colleagues pursued big dreams. Our first product was a U-shaped ceramic insulator (known as a Kelcima) for use within early television picture tubes.

Today, Kyocera is a highly diversified global enterprise. We pursue boundless dreams by accepting challenges that others timidly avoid.

We believe that a strong will can make dreams come true, and that limitless effort can overcome any obstacle. These beliefs from Kyocera's history remain the driving force behind our growth.

We aim to become a creative company that grows continuously throughout the future. Kyocera Group employees around the world who have adopted this challenging spirit personify our path to growth.

The cover design features illustrations of the U-shaped Kelcima.

Inquiries

**KYOCERA Corporation
Headquarters Planning
and Policy Division**

6 Takeda Tobadono-cho
Fushimi-ku Kyoto 612-8501,
Japan

<http://global.kyocera.com>
<http://www.kyocera.co.jp>