

THE NEW VALUE FRONTIER



High Efficiency and High Feed Cutter

MFH Series

High Efficiency and High Feed Cutter

MFH Series

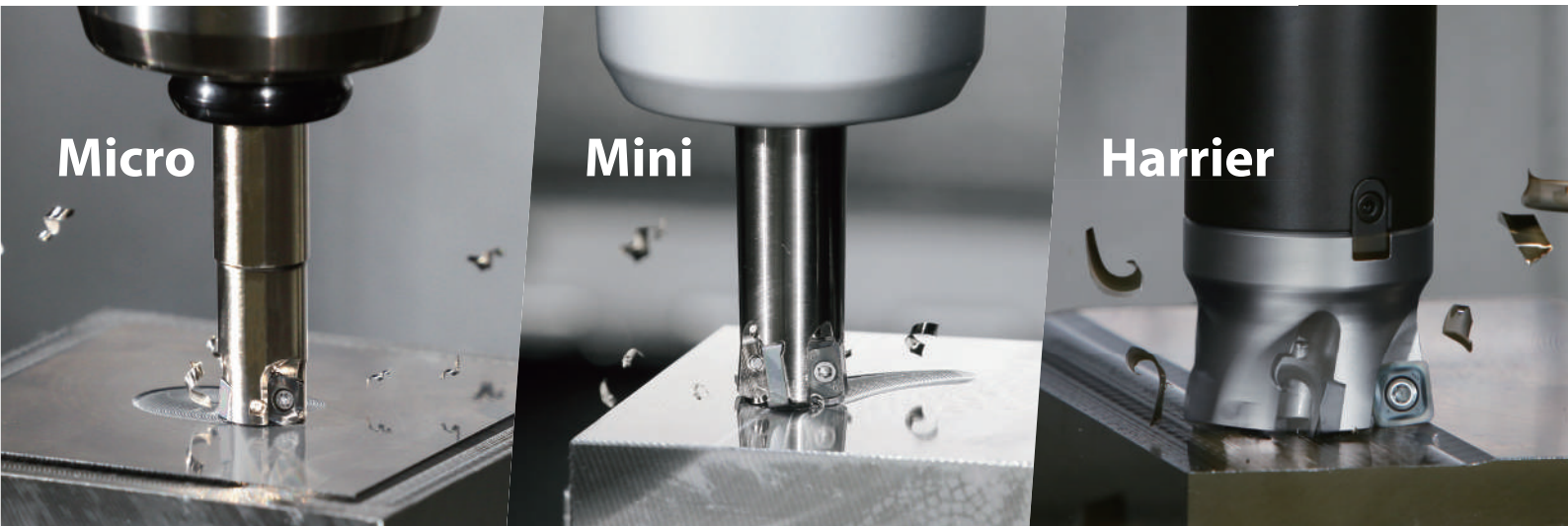

Stable Machining with Greater Chatter Resistance

Cutting Diameters Starting at $\varnothing 8\text{mm}$

Reduce Cycle Time During Roughing Applications

MFH Mini / Micro High Feed Mills for Small Machining Centers

NEW

GH Chipbreaker and PR015S Added to Lineup



MFH Micro
 $\varnothing 8\sim\varnothing 16$

MFH Mini
 $\varnothing 16\sim\varnothing 50$

MFH Harrier
 $\varnothing 25\sim\varnothing 160$

Micro Dia. Cutter for High Feed Machining

MFH Micro

Cutter Dia. $\phi 8 - \phi 16$

Low Resistance and Durable Against Chatter for Highly Efficient Machining

Maximum ap 0.5 mm. Stable High Feed Machining on a Wide Range of Applications

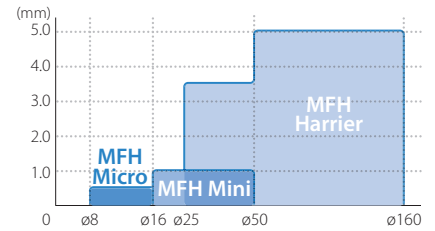

1 Low Resistance and Durable Against Chatter

Molded Convex Cutting Edge Controls Initial Impact when Entering the Workpiece

Cutting Force Comparison (Internal Evaluation)

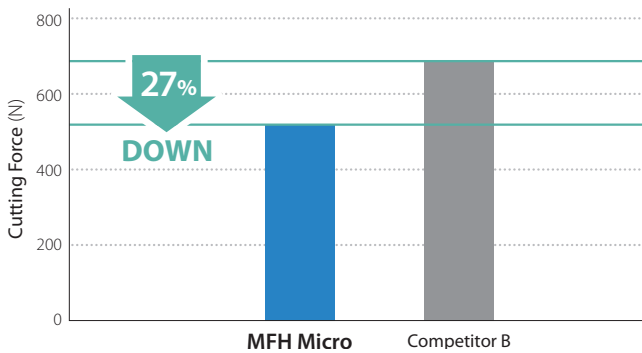

Cutting Conditions : $V_c = 120$ m/min, $f_z = 0.6$ mm/t, $a_p = 0.4$ mm
Cutter Dia. DC = $\phi 10$ mm, Slotting, Dry Workpiece: S50C

Cutting Force when Entering Workpiece Comparison (Internal Evaluation)

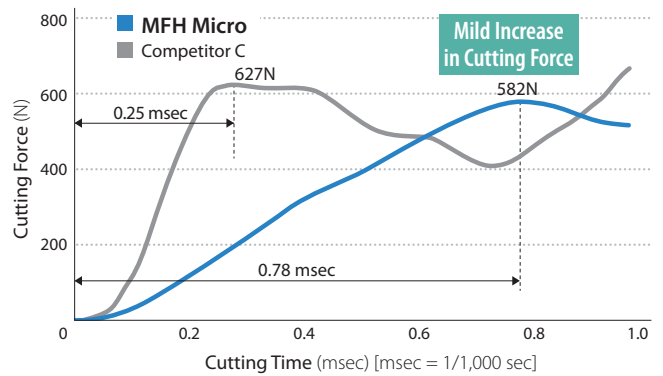

Cutting Conditions : $V_c = 120$ m/min, $f_z = 0.6$ mm/t, $a_p \times a_e = 0.4 \times 5$ mm
Cutter Dia. DC = $\phi 10$ mm, Dry Workpiece: S50C

2 Wide Range of Machining Applications

Wide Range of Machining Applications at a Maximum Depth of Cut of 0.5 mm

Stable Machining Even with Small Machining Center (BT30)

Cutting Performance Map (Cutter Dia. $\phi 10$ mm)

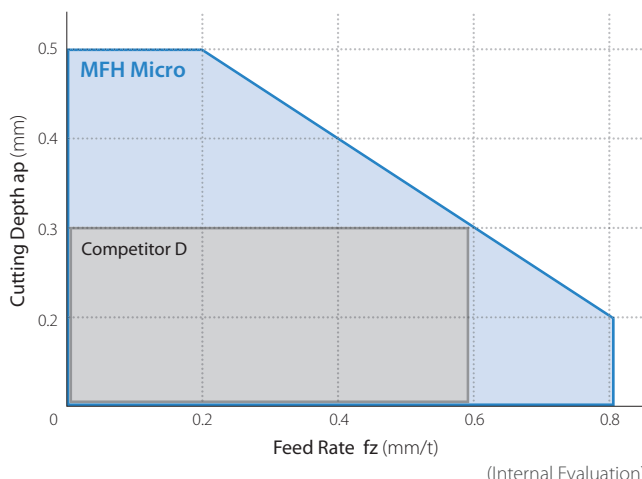

3 Replaces Solid End Mills to Reduce Machining Costs

Suppresses Chattering and Increases Milling Efficiency

MFH Micro Compared to Solid End Mills (Mechanical Parts, Slotting, Workpiece S50C)

MFH Micro	Solid End Mill
$Q = 15.3$ cc/min	$Q = 12.2$ cc/min
$V_c = 150$ m/min, $f_z = 0.4$ mm/t	$V_c = 80$ m/min, $f_z = 0.04$ mm/t
$a_p \times a_e = 0.4 \times 10$ mm, Dry	$a_p \times a_e = 3 \times 10$ mm, Dry
MFH10-S10-01-2T (2 Inserts)	$\phi 10$ (4 Flutes)
LPGT010210ER-GM (PR1525)	

x 1.25 Efficiency

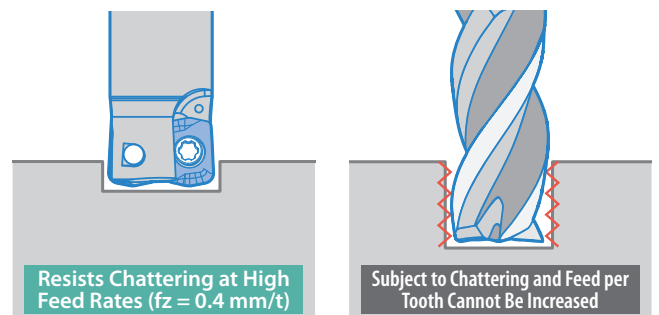

Small Dia. Cutter for High Feed Machining

MFH Mini

Cutter Dia. $\phi 16 - \phi 50$

Economical Inserts with 4 Cutting Edges

Small Dia. Fine Pitch Type for High Efficiency and High Feed Machining

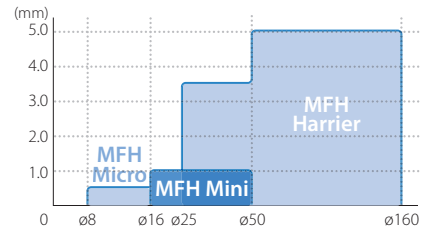

NEW GH Chipbreaker
Now Available



1 Good Chip Evacuation

MFH Mini Controls Chip Biting with Convex Cutting Edge

MFH Mini

Good Chip Evacuation

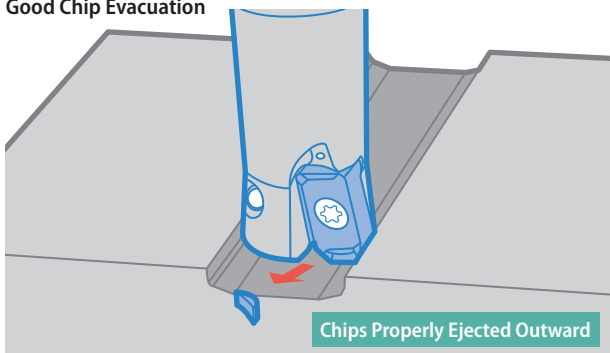

High Quality Surface Finish



Competitor High Feed Cutter

Poor Chip Evacuation

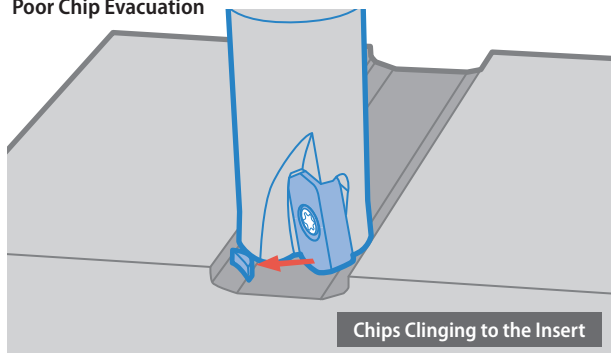

Chip Biting in the Workpiece



Cutting Conditions: Cutter Dia. DC = $\phi 16$ mm (2 Inserts), $V_c = 150$ m/min, $f_z = 0.6$ mm/t, $a_p = 0.5$ mm (20pass): Total 10 mm x 16 mm, Dry Workpiece: SS400

2 Fine Pitch for Efficient Machining

Cutter Dia. 25 mm Type

MFH Mini

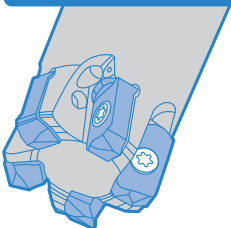

5 Inserts MFH25-S25-03-5T

MFH Harrier

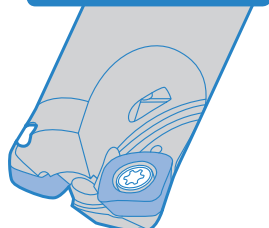

2 Inserts MFH25-S25-10-2T

3 Suitable for Roughing of Molds

High Feed Machining in Small Machining Centers

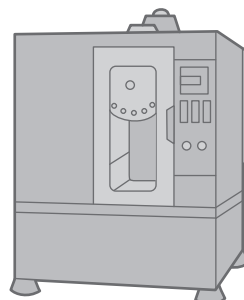

Applicable for BT30/ BT40

Highly Efficiency and High Feed Cutter

MFH Harrier

Cutter Dia. $\phi 25 - \phi 160$

Wide Range of Products for High Feed Machining
Large Depths of Cut and Low Cutting Forces

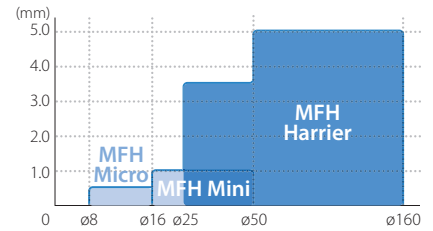

1 GH Chipbreaker is Now Available. Large Insert Lineup for Various Applications

GM (General Purpose)

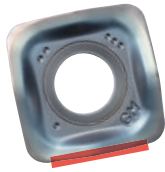

First Recommendation for General Machining

Multiple Metalworking Processes

GH (Tough Edge)

NEW

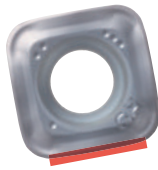

Excellent Fracture Resistance

LP (Large ap)

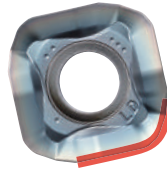

MAX. ap = 5 mm

Available for Scale Removal as well as High Feed Cutting

FL (Wiper Edge)

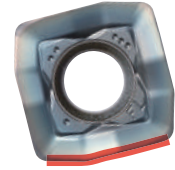

Wiper Edge with Low Cutting Forces

Excellent Surface Finish and Reduced Chattering

GH Chipbreaker with Excellent Fracture Resistance

Convex Cutting Edge Design

Reduces cutting force when entering workpiece
Suppresses chattering and fracturing

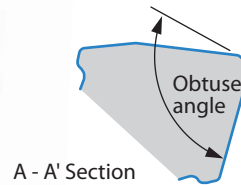

Tough Edge Design

Combining with PR015S is suitable for machining hardened material
Improved fracture resistance

Featured Product

LD Chipbreaker Can Be Used for Both Large ap and High Feed Machining

Large ap for Scale Removal

ap = 4.0 mm

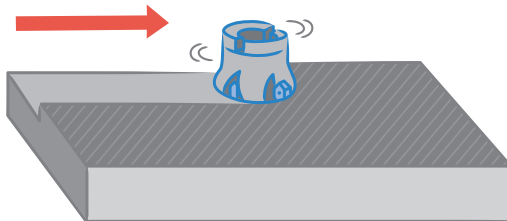

(fz = 0.25 mm/t, ap = 4 mm)

High Feed Rates After Scale Removal

fz = 1.5 mm/t

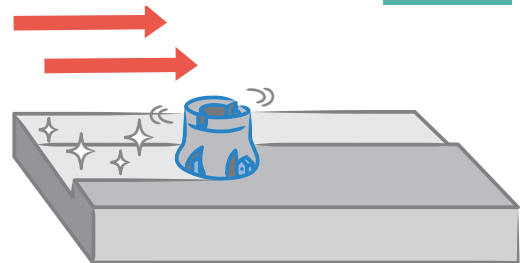

(fz = 1.5 mm/t, ap = 2 mm)

MFH Harrier

MFH063R-14-5T-22M
(Cutter Dia. 63 mm, 5 Inserts)

Roughing for Scale Removal (2 Passes): Large ap

Vc = 200 m/min, fz = 0.25 mm/t
ap x ae = 4 x 40 mm, Vf = 1,264 mm/min

Roughing (2 Passes) After Scale Removal: High Feed Rate

Vc = 200 m/min, fz = 1.5 mm/t
ap x ae = 2 x 40 mm, Vf = 7,583 mm/min
Workpiece : SS400

Conventional 45° Cutter Cutter Dia. 63 mm, 5 Inserts

Roughing (4 Passes): Constant D.O.C. and Feed Rate

Vc = 200 m/min, fz = 0.25 mm/t
ap x ae = 3 x 40 mm, Vf = 1,264 mm/min
Workpiece : SS400

Chip Evacuation

MFH

404 cc/min

Efficiency

x2.6

Conventional Cutter

151 cc/min

For General Steel/Alloy Steel/Difficult-to-Cut Material

MEGACOAT NANO PR1535

MEGACOAT NANO Grade PR1535 for stable machining of difficult-to-cut materials such as heat-resistant alloy, titanium alloy and precipitation hardened stainless steel

1 Toughening by a New Cobalt Mixing Ratio *Internal Evaluation

High Toughness Carbide Base Material

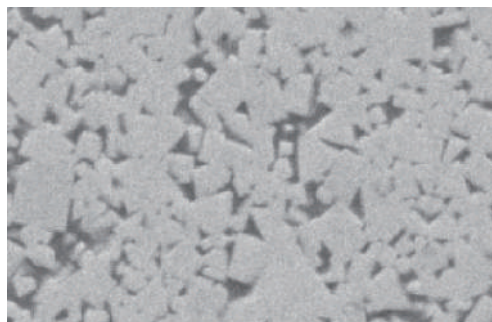

↑
23%
Fracture
Toughness*

2 Stability Improvement

The coarse grain structure and uniform particle size correspond to improved heat resistance, with conductivity values decreased by 11%. The uniform structure also reduces crack propagation.

↑
Shock
Resistance

Cracking Comparison by Diamond Indenter (Internal Evaluation)

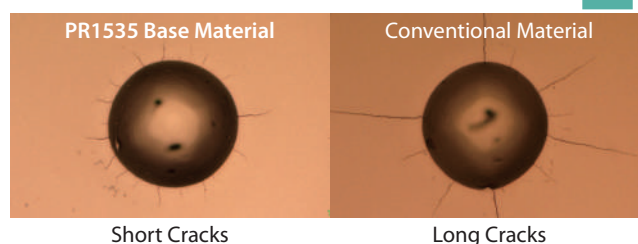

For Hardened Material

MEGACOAT HARD PR015S

Excellent thermal property of the substrate reduces cracks and notch wear. High hardness and heat resistant coating improves wear resistance. The combination enables stable machining in hardened materials.

High Hardness and High Heat-resistant PVD Layer MEGACOAT HARD Improves Wear Resistance

Coating Pattern Diagram

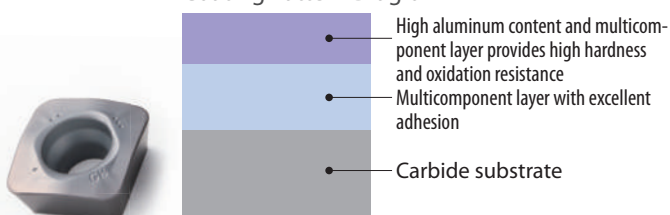

Coating Properties (Internal Evaluation)

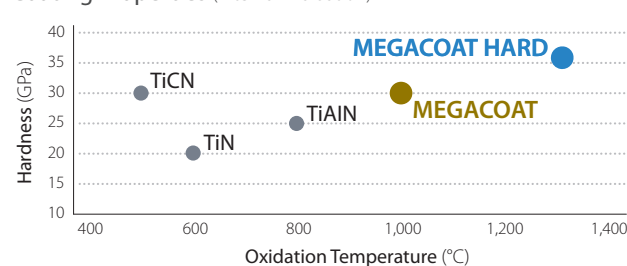

Combining GH Chipbreaker and PR015S Reduces Heat-cracks and Improves Fracture Resistance
Stable Machining in Hardened Material

Low Oxidation Resistance High

Cutting Performance Comparison (Internal Evaluation)

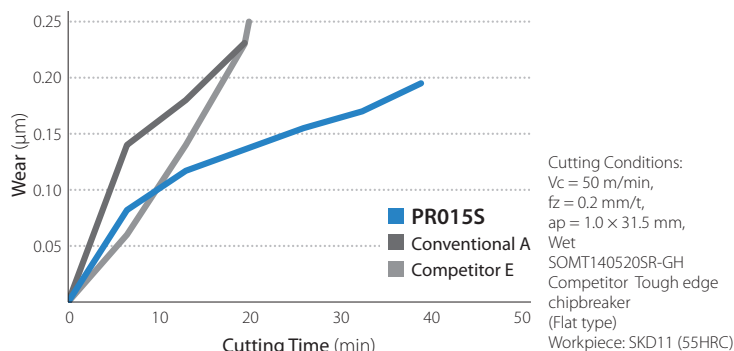

Cutting Edge

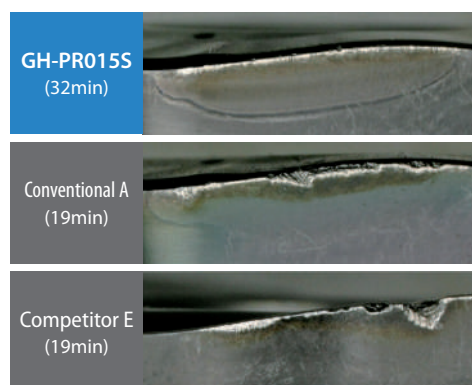

MFH Micro | End Mill

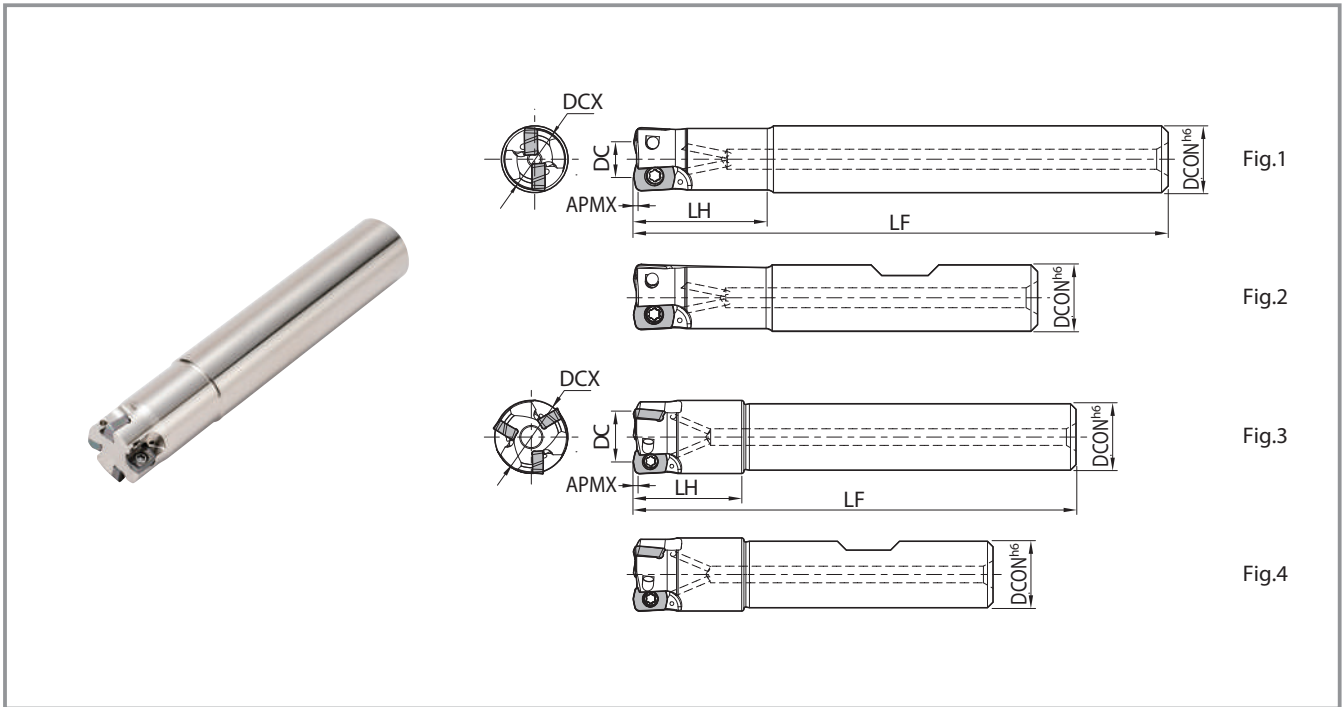

Toolholder Dimensions (Shank Type)

Shank	Description	Stock	No. of Inserts	Dimensions (mm)						Max. Ramping Angle	Rake Angle A.R.	Coolant Hole	Drawing	Weight (kg)	Max. Revolution (min ⁻¹)
				DCX	DC	DCON	LF	LH	APMX						
Standard (Straight)	MFH08-S10-01-1T	●	1	8	4.2	10	75	16	0.5	4°	+5°	Yes	Fig.1	0.04	20,000
	MFH10-S10-01-2T	●	2	10	6.2	10	80	20		3°				0.04	16,200
	MFH12-S12-01-3T	●	3	12	8.2	12	80	20		2°				0.06	14,000
	MFH16-S16-01-4T	●	4	16	12.2	16	90	25		1.2°				0.12	11,400
Over Size (Straight)	MFH14-S12-01-3T	●	3	14	10.2	12	80	20	0.5	1.5°	+5°	Yes	Fig.3	0.07	12,500
Standard (Weldon)	MFH08-W10-01-1T	●	1	8	4.2	10	58	16	0.5	4°	+5°	Yes	Fig.2	0.03	20,000
	MFH10-W10-01-2T	●	2	10	6.2	10	60	20		3°				0.03	16,200
	MFH12-W12-01-3T	●	3	12	8.2	12	65	20		2°				0.05	14,000
	MFH16-W16-01-4T	●	4	16	12.2	16	73	25		1.2°				0.1	11,400
Over Size (Weldon)	MFH14-W12-01-3T	●	3	14	10.2	12	65	20	0.5	1.5°	+5°	Yes	Fig.4	0.05	12,500

● : Std. Item

• Caution with Max. Revolution

Set the number of revolutions per minute within the recommended cutting speed specified by the workpiece on page 8.
Do not use the end mill or cutter at the maximum revolution or higher since the centrifugal force may cause chips and parts to scatter even under no load.

Spare Parts and Applicable Inserts

Description	Spare Parts			Applicable Inserts
	Clamp Screw	Wrench	Anti-Seize Compound	
MFH...-01-...	SB-1840TRP Recommended Torque for Insert Clamp 0.5N·m	FTP-6	P-37	LPGT010210ER-GM

• Coat Anti-Seize Compound (P-37) thinly on portion of taper and thread prior to installation.

MFH Micro | Head

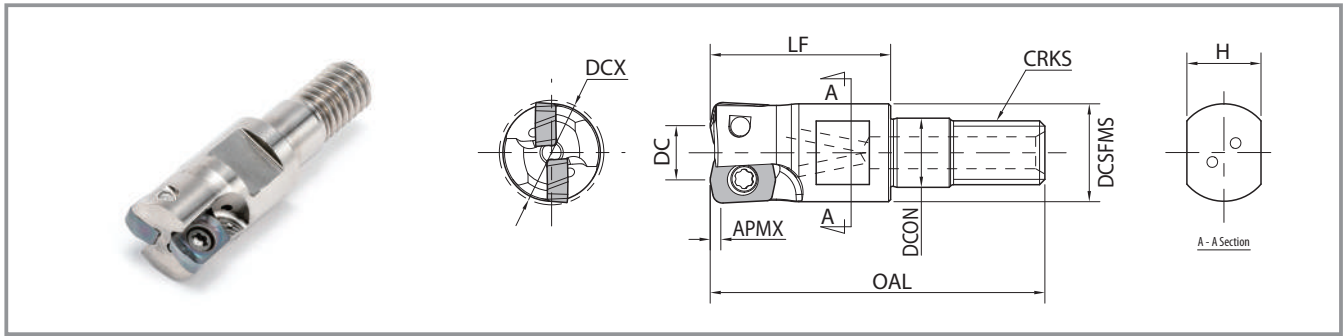

Toolholder Dimensions

Description	Stock	No. of Inserts	Dimensions (mm)								Max. Ramping Angle	Rake Angle A.R.	Coolant Hole	Max. Revolution (min ⁻¹)	
			DCX	DC	DCSFMS	DCON	OAL	LF	CRKS	H					APMX
MFH08-M06-01-1T	●	1	8	4.2	9.2	6.5	30.5	17	M6×P1.0	7	0.5	4°	+5°	Yes	20,000
MFH10-M06-01-2T	●	2	10	6.2								3°			16,200
MFH12-M06-01-3T	●	3	12	8.2	11.2	8.5	39	22	M8×P1.25	12	2°	14,000			
MFH14-M06-01-3T	●	3	14	10.2							1.5°	12,500			
MFH16-M08-01-4T	●	4	16	12.2	14.7	8.5	39	22	M8×P1.25	12	1.2°	11,400			

Industry standard threads for adapting to common toolholders (For ø8 - ø14 screw size: M6 x P1.0)
Check screw specifications for the shank in use.

● : Std. Item

Spare Parts and Applicable Inserts

Description	Spare Parts			Applicable Inserts
	Clamp Screw	Wrench	Anti-Seize Compound	
MFH...-01-...	 SB-1840TRP Recommended Torque for Insert Clamp 0.5N·m	 FTP-6	 P-37	LPGT010210ER-GM

• Caution with Max. Revolution

Set the number of revolutions per minute within the recommended cutting speed specified by the workpiece on page 8.
Do not use the end mill or cutter at the maximum revolution or higher since the centrifugal force may cause chips and parts to scatter even under no load.

• Coat Anti-Seize Compound (P-37) thinly on portion of taper and thread prior to installation.

Actual End Mill Depth (MFH16-M08-01-4T)

	Arbor Description	Applicable End Mill (Head)			Actual End Mill Depth (mm)
		Description	Cutter Dia.	Dimensions	LUX
			DC	LF	
	BT30K-M08-45	MFH16-M08-01...	16	22	28.8
	BT40K-M08-55	MFH16-M08-01...	16	22	28.7

For BT Type Arbor, See Page 21

MFH Micro | Applicable Inserts

Insert	Description	Dimensions (mm)					MEGACOAT NANO		CVD Coated Carbide
		W1	S	D1	INSL	RE	PR1535	PR1525	CA6535
 General Purpose 	LPGT 010210ER-GM	4.19	2.19	2.1	6.26	1.0	●	●	●

● : Std. Item

MFH Micro | Cutting Performance

Cutting Diameter: $\varnothing 8 - \varnothing 12$

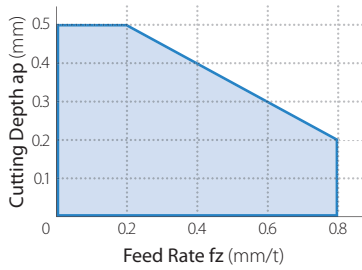

Cutting Diameter: $\varnothing 14 - \varnothing 16$

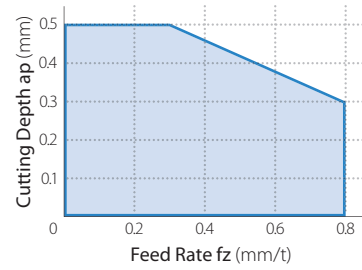

MFH Micro | Recommended Cutting Conditions ★1st Recommendation ☆2nd Recommendation

Insert	Workpiece	Holder Description and Feed Rate (fz: mm/t) Recommended Feed ap = 0.3 mm (reference value)					Recommended Insert Grade (Vc: m/min)		
		MFH08-... -1T	MFH10-... -2T	MFH12-... -3T	MFH14-... -3T	MFH16-... -4T	MEGACOAT NANO		CVD Coated Carbide
							PR1525	PR1535	CA6535
GM	Carbon Steel (SxxC)	0.2 - 0.4 - 0.6			0.2 - 0.5 - 0.8		★ 120 - 180 - 250	☆ 120 - 180 - 250	-
	Alloy Steel (SCM)	0.2 - 0.4 - 0.6			0.2 - 0.5 - 0.8		★ 100 - 160 - 220	☆ 100 - 160 - 220	-
	Die Steel (SKD)(~40HRC)	0.2 - 0.3 - 0.5			0.2 - 0.4 - 0.6		★ 80 - 140 - 180	☆ 80 - 140 - 180	-
	Die Steel (SKD)(40~50HRC)	0.2 - 0.25 - 0.3			0.2 - 0.25 - 0.4		★ 60 - 100 - 130	☆ 60 - 100 - 130	-
	Austenitic Stainless Steel (SUS304)	0.2 - 0.3 - 0.5			0.2 - 0.4 - 0.6		☆ 100 - 160 - 200	★ 100 - 160 - 200	-
	Martensitic Stainless Steel (SUS403)	0.2 - 0.3 - 0.5			0.2 - 0.4 - 0.6		-	☆ 150 - 200 - 250	★ 180 - 240 - 300
	Precipitation Hardened Stainless Steel (SUS630)	0.2 - 0.3 - 0.5			0.2 - 0.4 - 0.6		-	★ 90 - 120 - 150	-
	Gray Cast Iron (FC)	0.2 - 0.4 - 0.6			0.2 - 0.5 - 0.8		★ 120 - 180 - 250	-	-
	Nodular Cast Iron (FCD)	0.2 - 0.3 - 0.5			0.2 - 0.4 - 0.6		★ 100 - 150 - 200	-	-
	Ni-base Heat-Resistant Alloy	0.2 - 0.25 - 0.3			0.2 - 0.25 - 0.4		-	☆ 20 - 30 - 50	★ 20 - 30 - 50
	Titanium Alloy (Ti-6Al-4V)	0.2 - 0.25 - 0.3			0.2 - 0.25 - 0.4		-	★ 40 - 60 - 80	-

Machining with coolant is recommended for Ni-base heat resistant alloy and titanium alloy
 The number in bold font is recommended starting conditions. Adjust the cutting speed and the feed rate within the above conditions according to the actual machining situation
 Internal coolant is recommended for slotting applications

Case Studies

Mold SKD61

Vc = 90 m/min (n = 2,400 min⁻¹)
 ap x ae = 0.3 x ~ 0.7 mm
 fz = 0.27 mm/t (Vf = 1,930 mm/min)
 Dry
 MFH12-S12-01-3T (3 Inserts)
 LPGT010210ER-GM PR1535

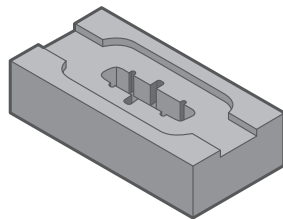

Chip Evacuation

PR1535 $\varnothing 12-3T$ **4.5 cc/min** ↑ **Efficiency x1.3**

Competitor F $\varnothing 12-3T$ **3.4 cc/min**

PR1535 shows 1.3 times machining efficiency compared to Competitor F
 Good cutting edge condition after machining almost doubling the tool life
 (User Evaluation)

Industrial Machine Parts SUS440C

Vc = 180 m/min (n = 3,580 min⁻¹)
 ap x ae = 0.4 x 8 mm
 fz = 0.4 mm/t (Vf = 5,730 mm/min)
 Wet
 MFH16-S16-01-4T (4 Inserts)
 LPGT010210ER-GM PR1535

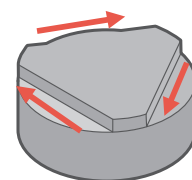

Cutting Time

PR1535 **7 min** ↓ **35% Cutting Time**

Competitor G **11 min**

PR1535 shows 30% faster cycle time compared to competitor G
 (User Evaluation)

MFH Mini | End Mill

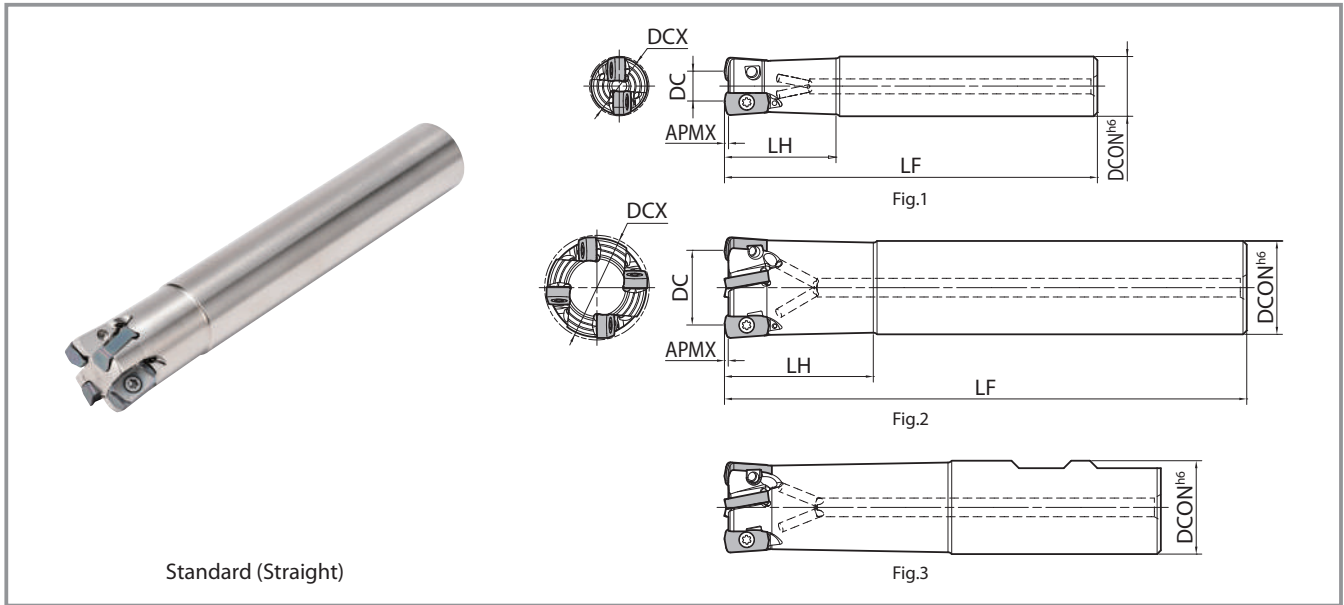

Toolholder Dimensions

Shank	Description	Stock	No. of Inserts	Dimensions (mm)						Rake Angle	Coolant Hole	Drawing	Weight (kg)	Max. Revolution (min ⁻¹)						
				DCX	DC	DCON	LF	LH	APMX	A.R.										
Standard (Straight)	MFH 16-S16-03-2T	●	2	16	8	16	100	30	1	-10°	Yes	Fig.1	0.1	18,800						
	MFH 20-S20-03-3T	●	3	20	12	20	130	50					0.3	15,700						
	20-S20-03-4T	●	4	20	12	20	130	50					0.3	15,700						
	MFH 25-S25-03-4T	●	4	25	17	25	140	60					0.5	13,400						
	25-S25-03-5T	●	5	25	17	25	140	60					0.5	13,400						
	MFH 32-S32-03-5T	●	5	32	24	32	150	70					0.8	11,400						
32-S32-03-6T	●	6	32	24	32	150	70	0.8				11,400								
Over Size (Straight)	MFH 17-S16-03-2T	●	2	17	9	16	100	20				1	-10°	Yes	Fig.2	0.1	17,900			
	MFH 18-S16-03-2T	●	2	18	10	16	100	20								0.1	17,000			
	MFH 22-S20-03-3T	●	3	22	14	20	130	30								0.3	14,700			
	22-S20-03-4T	●	4	22	14	20	130	30								0.3	14,700			
	MFH 28-S25-03-4T	●	4	28	20	25	140	40								0.5	12,400			
	28-S25-03-5T	●	5	28	20	25	140	40								0.5	12,400			
Standard (Weldon)	MFH 16-W16-03-2T	●	2	16	8	16	79	30							1	-10°	Yes	Fig.3	0.1	18,800
	MFH 20-W20-03-3T	●	3	20	12	20	101	50											0.2	15,700
	20-W20-03-4T	●	4	20	12	20	101	50											0.2	15,700
	MFH 25-W25-03-4T	●	4	25	17	25	117	60											0.4	13,400
	25-W25-03-5T	●	5	25	17	25	117	60											0.4	13,400
	MFH 32-W32-03-5T	●	5	32	24	32	131	70	0.7	11,400										
32-W32-03-6T	●	6	32	24	32	131	70	0.7	11,400											
Long Shank (Straight)	MFH 16-S16-03-2T-150	●	2	16	8	16	150	50	1	-10°	Yes	Fig.1	0.2	18,800						
	MFH 20-S20-03-3T-160	●	3	20	12	20	160	80					0.3	15,700						
	MFH 25-S25-03-4T-180	●	4	25	17	25	180	100					0.6	13,400						
	MFH 32-S32-03-5T-200	●	5	32	24	32	200	120					1.1	11,400						

● : Std. Item

Spare Parts and Applicable Inserts

Description	Spare Parts			Applicable Inserts
	Clamp Screw	Wrench	Anti-Seize Compound	
MFH...-03-...	SB-3065TRP	DTPM-8	P-37	LOGU030310ER-GM LOGU030310ER-GH
Recommended Torque for Insert Clamp 1.2N·m				

Caution with Max. Revolution

Set the number of revolutions per minute within the recommended cutting speed specified by the workpiece on page 12.

Do not use the end mill or cutter at the maximum revolution or higher since the centrifugal force may cause chips and parts to scatter even under no load.

Coat Anti-Seize Compound (P-37) thinly on portion of taper and thread prior to installation.

MFH Mini | Face Mill

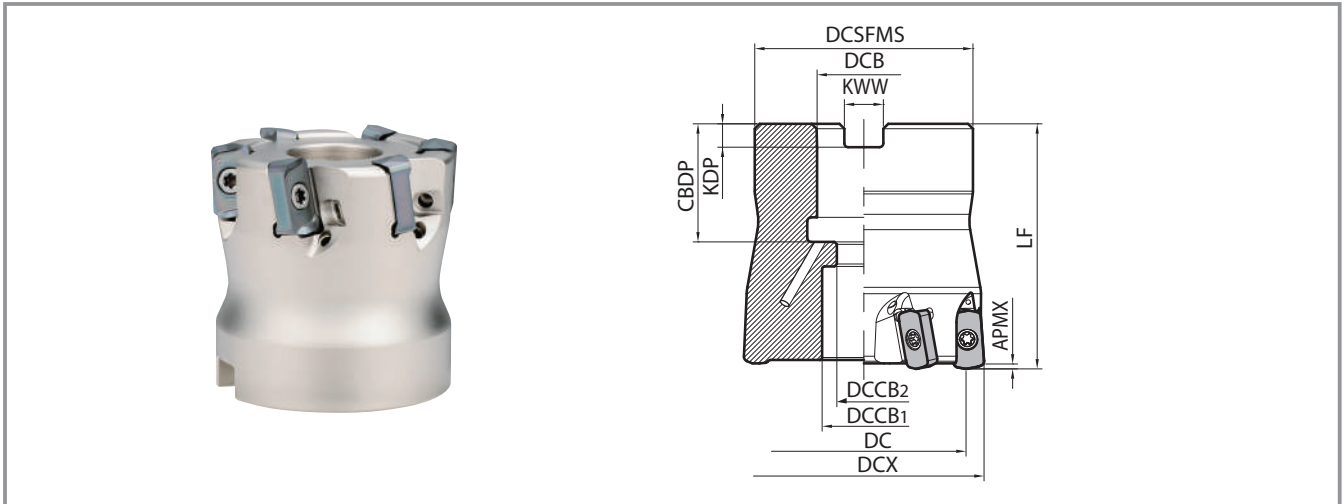

Toolholder Dimensions

Bore Dia.	Description	Stock	No. of Inserts	Dimensions (mm)										Rake Angle		Coolant Hole	Weight (kg)	Max. Revolution (min ⁻¹)
				DCX	DC	DCSFMS	DCB	DCCB ₁	DCCB ₂	LF	CBDP	KDP	KWW	APMX	A.R.			
Metric Spec	MFH 040R-03-5T-M	●	5	40	32	38	16	15	9	40	19	5.6	8.4	1	-10°	Yes	0.2	9,900
	MFH 040R-03-6T-M	●	6	40	32	38	16	15	9	40	19	5.6	8.4					
	MFH 050R-03-8T-M	●	8	50	42	47	22	19	11	50	21	6.3	10.4				0.5	8,600

• Caution with Max. Revolution

Set the number of revolutions per minute within the recommended cutting speed specified by the workpiece on page 12. Do not use the end mill or cutter at the maximum revolution or higher since the centrifugal force may cause chips and parts to scatter even under no load.

● : Std. Item

MFH Mini | Head

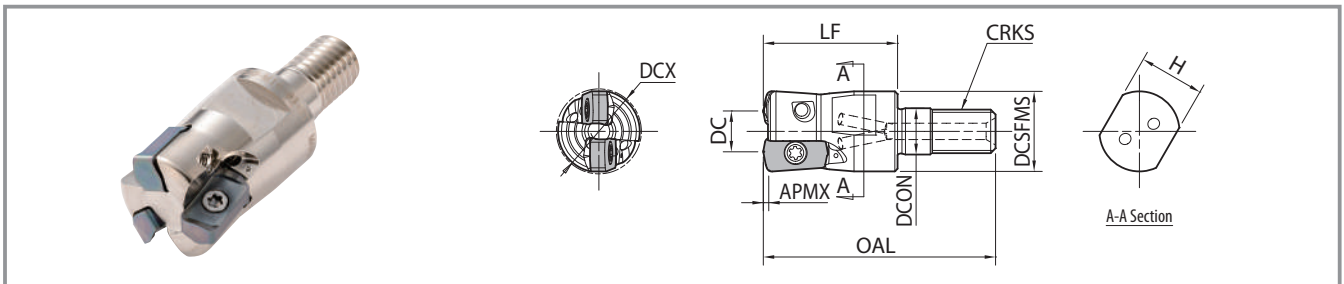

Toolholder Dimensions

Description	Stock	No. of Inserts	Dimensions (mm)									Rake Angle		Coolant Hole	Max. Revolution (min ⁻¹)
			DCX	DC	DCSFMS	DCON	OAL	LF	CRKS	H	APMX	A.R.			
MFH 16-M08-03-2T	●	2	16	8	14.7	8.5	42	25	M8×P1.25	12	1	-10°	Yes	18,880	
MFH 17-M08-03-2T	●	2	17	9	14.7	8.5	42	25	M8×P1.25	12				17,900	
MFH 18-M08-03-2T	●	2	18	10	14.7	8.5	42	25	M8×P1.25	12				17,000	
MFH 20-M10-03-3T	●	3	20	12	18.7	10.5	48	30	M10×P1.5	15				15,700	
MFH 20-M10-03-4T	●	4	20	12	18.7	10.5	48	30	M10×P1.5	15				15,700	
MFH 22-M10-03-3T	●	3	22	14	18.7	10.5	48	30	M10×P1.5	15				14,700	
MFH 22-M10-03-4T	●	4	22	14	18.7	10.5	48	30	M10×P1.5	15				14,700	
MFH 25-M12-03-4T	●	4	25	17	23	12.5	56	35	M12×P1.75	19				13,400	
MFH 25-M12-03-5T	●	5	25	17	23	12.5	56	35	M12×P1.75	19				13,400	
MFH 28-M12-03-4T	●	4	28	20	23	12.5	56	35	M12×P1.75	19				12,400	
MFH 28-M12-03-5T	●	5	28	20	23	12.5	56	35	M12×P1.75	19				12,400	
MFH 32-M16-03-5T	●	5	32	24	30	17	62	40	M16×P2.0	24				11,400	
MFH 32-M16-03-6T	●	6	32	24	30	17	62	40	M16×P2.0	24				11,400	

• Caution with Max. Revolution

Set the number of revolutions per minute within the recommended cutting speed specified by the workpiece on page 12. Do not use the end mill or cutter at the maximum revolution or higher since the centrifugal force may cause chips and parts to scatter even under no load.

● : Std. Item

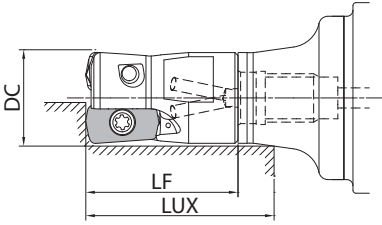

Actual End Mill Depth



Arbor Description	Applicable End Mill (Head)			Actual End Mill Depth (mm)
	Description	Cutting Dia.	Dimension	
		DC	LF	LUX
BT30K-M08-45	MFH16-M08-03...	16	25	31.8
	MFH17-M08-03...	17	25	33.2
	MFH18-M08-03...	18	25	34.2
BT30K-M10-45	MFH20-M10-03...	20	30	36.8
	MFH22-M10-03...	22	30	39.2
BT30K-M12-45	MFH25-M12-03...	25	35	42.8
	MFH28-M12-03...	28	35	45.5
BT40K-M08-55	MFH16-M08-03...	16	25	31.7
	MFH17-M08-03...	17	25	33.2
	MFH18-M08-03...	18	25	34.3
BT40K-M10-60	MFH20-M10-03...	20	30	38.7
	MFH22-M10-03...	22	30	44.5
BT40K-M12-55	MFH25-M12-03...	25	35	44.6
	MFH28-M12-03...	28	35	47.6
BT40K-M16-65	MFH32-M16-03...	32	40	51.2

For BT Type Arbor, See Page 21

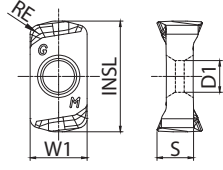
MFH Mini | Applicable Inserts

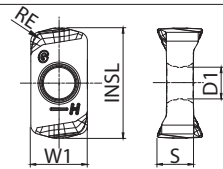
Insert	Description	Dimensions (mm)					MEGACOAT NANO			MEGACOAT HARD	CVD Coated Carbide
		W1	S	D1	INSL	RE	PR1535	PR1525	PR1510	PR0155	CA6535
 General Purpose 	LOGU030310ER-GM	6.2	3.96	3.45	11.9	1.0	●	●	●	-	●
 Tough Edge 	LOGU030310ER-GH	6.2	3.96	3.45	11.9	1.0	●	●	●	●	-

●: Std. Item

MFH Mini | Cutting Performance

Fine Pitch

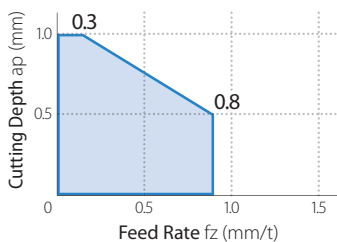

MFH20-...-4T, MFH22-...-4T,
MFH25-...-5T, MFH28-...-5T,
MF32-...-6T

Standard Pitch (Cutter Dia. 16 – 22 mm)

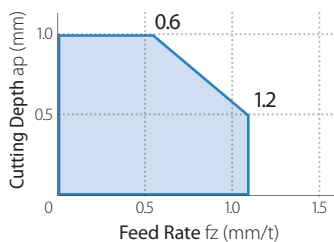

MFH16-...-2T, MFH17-...-2T,
MFH18-...-2T, MFH20-...-3T,
MFH22-...-3T

Face Mill (Cutter Dia. 40 – 50 mm) Standard Pitch (Cutter Dia. 25 – 32 mm)

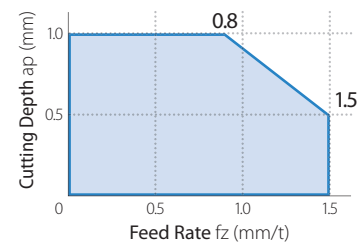

MFH25-...-4T, MFH28-...-4T,
MFH32-...-5T, MFH040R-...,
MFH050R-...

Caution:
When using fine pitch, reduce the cutting conditions compared with standard type

Insert	Workpiece	Holder Description and Feed Rate (fz: mm/t) Recommended Feed ap = 0.5 mm (reference value)							Recommended Insert Grade (Vc: m/min)					
		MFH16 -...-2T	MFH20 -...-3T	MFH20 -...-4T	MFH25 -...-4T	MFH25 -...-5T	MFH32 -...-5T	MFH32 -...-6T	MFH -...-R-03	MEGACOAT NANO			MEGACOAT HARD	CVD Coated Carbide
										PR1535	PR1525	PR1510	PR0155	CA6535
Die Steel	Carbon Steel (SxxC)	0.2 - 0.7 - 1.2	0.2 - 0.5 - 0.8	0.2 - 0.8 - 1.5	0.2 - 0.5 - 0.8	0.2 - 0.8 - 1.5	0.2 - 0.5 - 0.8	0.2 - 0.5 - 0.8	☆	★	-	-	-	
	Alloy Steel (SCM)								120 - 180 - 250	120 - 180 - 250	-	-	-	
	(~40HRC)	0.2 - 0.5 - 0.9	0.2 - 0.4 - 0.6	0.2 - 0.6 - 1.2	0.2 - 0.4 - 0.6	0.2 - 0.6 - 1.2	0.2 - 0.4 - 0.6	0.2 - 0.4 - 0.6	☆	☆	-	GH★	-	
	(40~50HRC)	0.2 - 0.3 - 0.5	0.2 - 0.25 - 0.3	0.2 - 0.3 - 0.6	0.2 - 0.25 - 0.3	0.2 - 0.3 - 0.6	0.2 - 0.25 - 0.3	0.2 - 0.25 - 0.3	-	☆	-	GH★	-	
	(50~55HRC)	0.1 - 0.3 - 0.5	0.1 - 0.2 - 0.3	0.1 - 0.3 - 0.5	0.1 - 0.2 - 0.3	0.1 - 0.3 - 0.5	0.1 - 0.2 - 0.3	0.1 - 0.2 - 0.3	-	☆	-	GH★	-	
(55~60HRC)	0.03 - 0.06 - 0.1 (* Recommended only for GH chipbreaker)							-	-	-	GH☆	-		
GM GH	Austenitic Stainless Steel (SUS304)								GM★	GM☆	-	-	-	
	Martensitic Stainless Steel (SUS403)	0.2 - 0.5 - 0.9	0.2 - 0.4 - 0.6	0.2 - 0.6 - 1.2	0.2 - 0.4 - 0.6	0.2 - 0.6 - 1.2	0.2 - 0.4 - 0.6	0.2 - 0.4 - 0.6	☆	-	-	-	★	
	Precipitation Hardened Stainless Steel (SUS630)								150 - 200 - 250	-	-	-	180 - 240 - 300	
	Gray Cast Iron (FC)	0.2 - 0.7 - 1.2	0.2 - 0.5 - 0.8	0.2 - 0.8 - 1.5	0.2 - 0.5 - 0.8	0.2 - 0.8 - 1.5	0.2 - 0.5 - 0.8	0.2 - 0.5 - 0.8	-	-	★	-	-	
	Nodular Cast Iron (FCD)	0.2 - 0.5 - 0.9	0.2 - 0.4 - 0.6	0.2 - 0.6 - 1.2	0.2 - 0.4 - 0.6	0.2 - 0.6 - 1.2	0.2 - 0.4 - 0.6	0.2 - 0.4 - 0.6	-	-	★	-	-	
	Ni-base Heat-Resistant Alloy	0.2 - 0.3 - 0.6	0.2 - 0.25 - 0.4	0.2 - 0.4 - 0.8	0.2 - 0.25 - 0.4	0.2 - 0.4 - 0.8	0.2 - 0.25 - 0.4	0.2 - 0.25 - 0.4	☆	-	-	-	-	★
	Titanium Alloy (Ti-6Al-4V)								20 - 30 - 50	-	-	-	20 - 30 - 50	
								GM★	-	GM☆	-	-		
								40 - 60 - 80	-	30 - 50 - 70	-	-		

- The number in bold font is recommended starting conditions. Adjust the cutting speed and the feed rate within the above conditions according to the actual machining situation
- Machining with coolant is recommended for Ni-base Heat Resistant Alloy and Titanium Alloy
- Machining with BT30 or equivalent, feed rate should be reduced to 25% of recommended cutting conditions
- Internal coolant is recommended for slotting applications
- Slotting and pocketing are not recommended for face mill type.

Standard Pitch Fine Pitch

Case Studies

Mold Parts Pre-hardened Steel

Vc = 220 m/min (n = 3,500 min⁻¹)
 ap x ae = 0.5 x 14 mm
 fz = 0.05 mm/t (Vf = 700 mm/min)
 Dry
 MFH20-S20-03-4T (4 Inserts)
 LOGU030310ER-GM PR1535

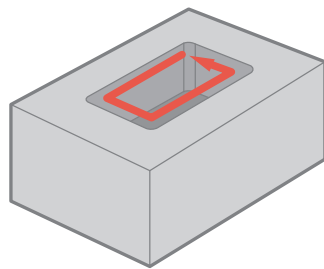

Tool Life

PR1535

2.0 H

Tool Life

MAX x2

Competitor H (4 Inserts)

1.0~1.5 H

PR1535 shows lower cutting load compared to competitor H and can extend the machining time.

(User Evaluation)

Airplane Parts Precipitation Hardened Stainless Steel

Vc = 120 m/min (n = 1,530 min⁻¹)
 ap x ae = 0.7 x ~ 25 mm
 fz = 0.6 mm/t (Vf = 3,670 mm/min)
 Dry
 MFH25-S25-03-4T (4 Inserts)
 LOGU030310ER-GM PR1535

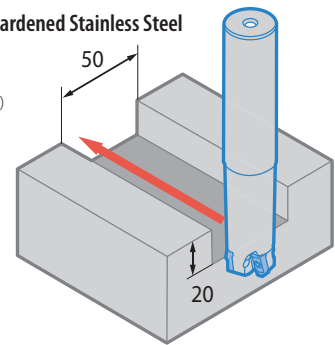

Number of Workpieces

PR1535

100 pcs

Tool Life

x1.8

Competitor I (5 Inserts)

55 pcs

PR1535 maintains good cutting edge condition after machining 100 pcs with stable machining.

(User Evaluation)

MFH Harrier | End Mill (SOMT10 Type)

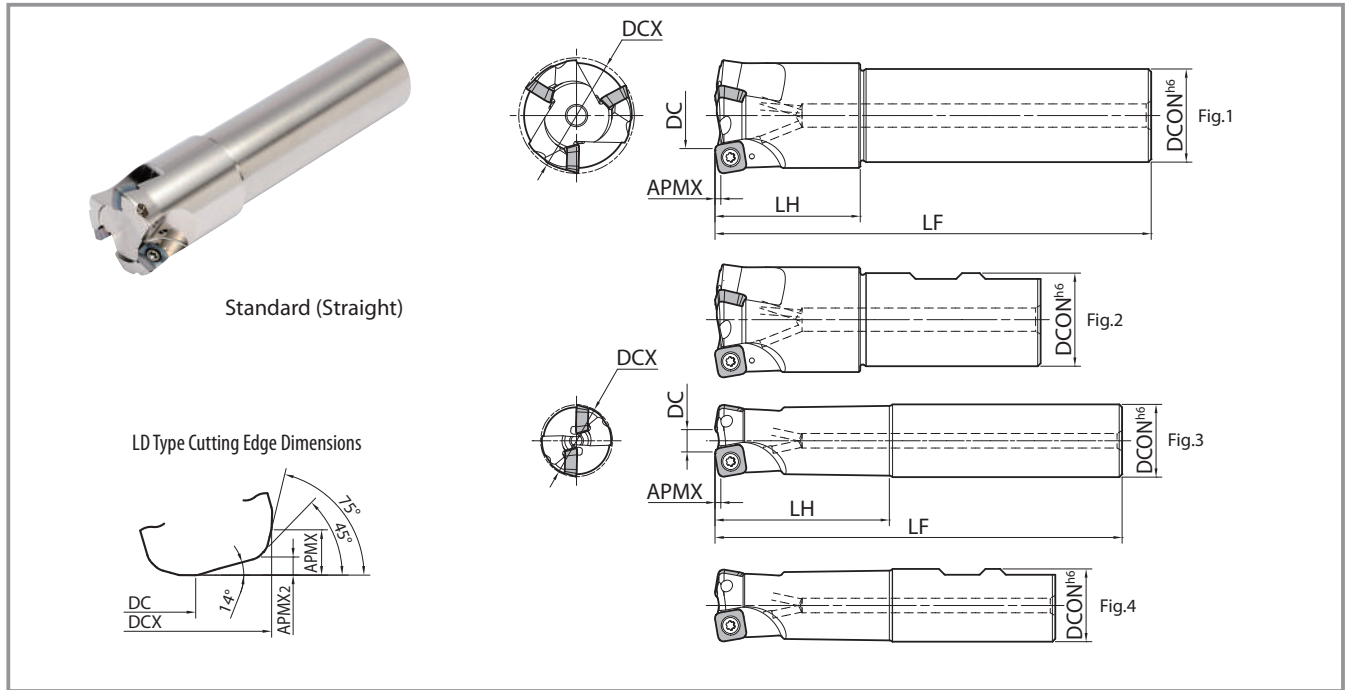

Toolholder Dimensions (SOMT10 Type)

Shank	Description	Stock	No. of Inserts	Dimensions (mm)								Rake Angle	Coolant Hole	Drawing	Weight (kg)	Max. Revolution (min ⁻¹)	
				DCX	GM-GH	LD	FL	DCON	LF	LH	APMX						APMX ₂
Standard (Straight)	MFH 25-S25-10-2T	●	2	25	8	12.5	11.5	25	140	60	1.5 (3.5) *	1.2	+10°	Yes	Fig.3	0.4	17,000
	MFH 28-S25-10-2T	●	2	28	11	15.5	14.5	25	140	40					Fig.1	0.5	15,500
	MFH 32-S32-10-2T	●	2	32	15	19.5	18.5	32	150	70					Fig.3	0.8	14,000
	32-S32-10-3T	●	3	32	15	19.5	18.5	32	150	70						0.8	14,000
	MFH 35-S32-10-2T	●	2	35	18	22.5	21.5	32	150	50					Fig.1	0.8	13,000
	35-S32-10-3T	●	3	35	18	22.5	21.5	32	150	50						0.8	13,000
	MFH 40-S32-10-3T	●	3	40	23	27.5	26.5	32	150	50						0.9	11,500
	40-S32-10-4T	●	4	40	23	27.5	26.5	32	150	50						0.9	11,500
Standard (Weldon)	MFH 25-W25-10-2T	●	2	25	8	12.5	11.5	25	117	60	1.5 (3.5) *	1.2	+10°	Yes	Fig.4	0.4	17,000
	MFH 32-W32-10-3T	●	3	32	15	19.5	18.5	32	131	70						0.7	14,000
	MFH 40-W32-10-3T	●	3	40	23	27.5	26.5	32	112	50					Fig.2	0.7	11,500
	40-W32-10-4T	●	4	40	23	27.5	26.5	32	112	50						0.7	11,500
Long Shank (Straight)	MFH 25-S25-10-2T-200	●	2	25	8	12.5	11.5	25	200	120	1.5 (3.5) *	1.2	+10°	Yes	Fig.3	0.6	17,000
	MFH 28-S25-10-2T-200	●	2	28	11	15.5	14.5	25	200	40					Fig.1	0.7	15,500
	MFH 32-S32-10-2T-200	●	2	32	15	19.5	18.5	32	200	120					Fig.3	1.0	14,000
	MFH 35-S32-10-2T-200	●	2	35	18	22.5	21.5	32	200	50						1.4	13,000
	MFH 40-S32-10-4T-250	●	4	40	23	27.5	26.5	32	250	50					Fig.1	1.5	11,500
Extra Long Shank (Straight)	MFH 25-S25-10-2T-300	●	2	25	8	12.5	11.5	25	300	180	1.5 (3.5) *	1.2	+10°	Yes	Fig.3	1.0	17,000
	MFH 28-S25-10-2T-300	●	2	28	11	15.5	14.5	25	300	40					Fig.1	1.1	15,500
	MFH 32-S32-10-2T-300	●	2	32	15	19.5	18.5	32	300	180					Fig.3	1.6	14,000
	MFH 35-S32-10-2T-300	●	2	35	18	22.5	21.5	32	300	50						Fig.1	1.7
	MFH 40-S32-10-4T-300	●	4	40	23	27.5	26.5	32	300	50				Fig.1	1.8	11,500	

* Dimension in () is when mounting LD Type ● : Std. Item

Spare Parts and Applicable Inserts

Description	Spare Parts			Applicable Inserts
	Clamp Screw	Wrench	Anti-Seize Compound	
MFH...-10-...	SB-4075TRP	DTPM-15	P-37	SOMT100420ER-GM SOMT100420ER-GH SOMT100420ER-LD SOMT100420ER-FL
	Recommended Torque for Insert Clamp 3.5N·m			

- **Caution with Max. Revolution**
Set the number of revolutions per minute within the recommended cutting speed specified by the workpiece on page 19-20.
Do not use the end mill or cutter at the maximum revolution or higher since the centrifugal force may cause chips and parts to scatter even under no load.
- Coat Anti-Seize Compound (P-37) thinly on portion of taper and thread prior to installation.

Recommended Cutting Conditions → P19, P20

MFH Harrier | End Mill (SOMT14 Type)

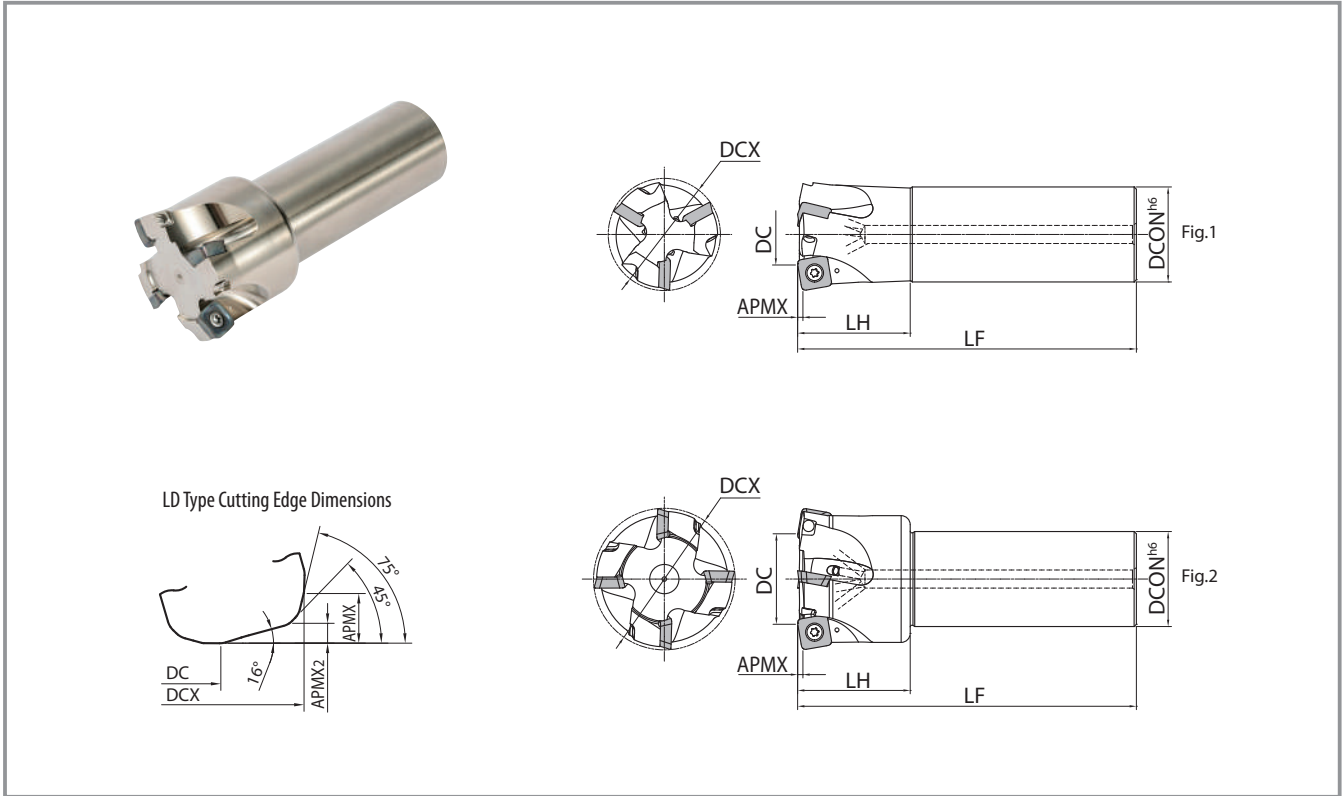

Toolholder Dimensions (SOMT14 Type)

Description	Stock	No. of Inserts	Dimensions (mm)									Rake Angle	Coolant Hole	Drawing	Weight (kg)	Max. Revolution (min ⁻¹)
			DCX	DC			DCON	LF	LH	APMX	APMX ₂					
GM•GH	LD	FL														
MFH50-S42-14-3T	●	3	50	27	33	32	42	150	50					Fig. 1	1.4	8,800
MFH63-S42-14-4T	●	4	63	40	46	45	42	150	50	2 *(5)	2	+10°	Yes	Fig. 2	1.7	7,400
MFH80-S42-14-5T	●	5	80	57	63	62	42	150	50						2.3	6,400

* Dimension in () is when mounting LD Type ●: Std. Item

Spare Parts and Applicable Inserts

Description	Spare Parts			Applicable Inserts
	Clamp Screw	Wrench	Anti-Seize Compound	
MFH...-14-...	 SB-50120TRP Recommended Torque for Insert Clamp 4.5N·m	 TTP-20	 P-37	SOMT140520ER-GM SOMT140520ER-GH SOMT140520ER-LD SOMT140514ER-FL

- **Caution with Max. Revolution**
Set the number of revolutions per minute within the recommended cutting speed specified by the workpiece on page 19-20. Do not use the end mill or cutter at the maximum revolution or higher since the centrifugal force may cause chips and parts to scatter even under no load.
- Coat Anti-Seize Compound (P-37) thinly on portion of taper and thread prior to installation.

Recommended Cutting Conditions → P19, P20

MFH Harrier | Face Mill

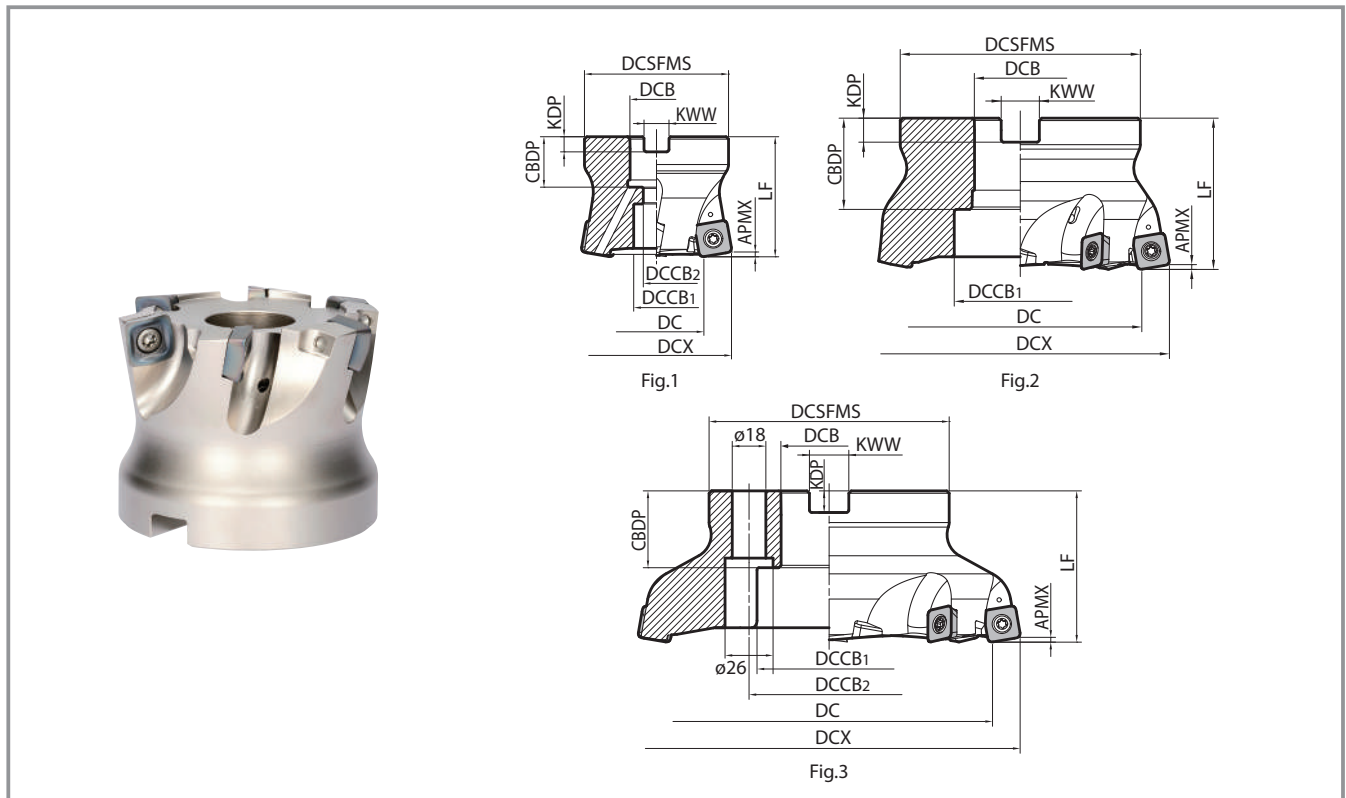

Toolholder Dimensions (SOMT10 Type)

Bore Dia.	Description	Stock	No. of Inserts	Dimensions (mm)													Rake Angle	Coolant Hole	Drawing	Weight (kg)	Max. Revolution (min ⁻¹)				
				DCX	DC			DCSFMS	DCB	DCCB ₁	DCCB ₂	LF	CBDP	KDP	KWW	APMX						APMX ₂ ^{*1}	A.R.		
					GM-GH	LD	FL																		
Inch Spec	MFH 050R-10-4T	●	4	50	33	37.5	36.5	47	22.225	19	11	50	19	5	8.4	1.5 (3.5) ^{*2}	1.2	+10°	Yes	Fig.1	0.4	10,000			
	050R-10-5T	●	5	50	33	37.5	36.5	47	22.225	19	11	50	19	5	8.4						0.4	10,000			
	MFH 063R-10-5T	●	5	63	46	50.5	49.5	60	22.225	19	11	50	19	5	8.4						0.7	8,800			
	063R-10-6T	●	6	63	46	50.5	49.5	60	22.225	19	11	50	19	5	8.4						0.7	8,800			
	MFH 080R-10-7T	●	7	80	63	67.5	66.5	76	31.75	26	17	63	32	8	12.7						1.3	7,600			
Metric Spec	MFH 050R-10-4T-M	●	4	50	33	37.5	36.5	47	22	19	11	50	21	6.3	10.4				1.5 (3.5) ^{*2}	1.2	+10°	Yes	Fig.1	0.4	10,000
	050R-10-5T-M	●	5	50	33	37.5	36.5	47	22	19	11	50	21	6.3	10.4									0.4	10,000
	MFH 063R-10-5T-22M	●	5	63	46	50.5	49.5	60	22	19	11	50	21	6.3	10.4									0.7	8,800
	063R-10-6T-22M	●	6	63	46	50.5	49.5	60	22	19	11	50	21	6.3	10.4									0.7	8,800
	063R-10-5T-27M	●	5	63	46	50.5	49.5	60	27	20	13	50	24	7	12.4									0.7	8,800
	063R-10-6T-27M	●	6	63	46	50.5	49.5	60	27	20	13	50	24	7	12.4	0.7	8,800								
	MFH 080R-10-7T-M	●	7	80	63	67.5	66.5	76	27	20	13	63	24	7	12.4	1.6	7,600								

• Caution with Max. Revolution

Set the number of revolutions per minute within the recommended cutting speed specified by the workpiece on page 19-20.
Do not use the end mill or cutter at the maximum revolution or higher since the centrifugal force may cause chips and parts to scatter even under no load.

*1 Refer to APMX 2 on Page 16 *2 Dimension in () is when mounting LD Type ● : Std. Item

Toolholder Dimensions (SOMT14 Type)

Bore Dia.	Description	Stock	No. of Inserts	Dimensions (mm)													Rake Angle		Coolant Hole	Drawing	Weight (kg)	Max. Revolution (min ⁻¹)		
				DCX	DC			DCSFMS	DCB	DCCB ₁	DCCB ₂	LF	CBDP	KDP	KWW	APMX	APMX ₂ *1	A.R.						
					GM-GH	LD	FL																	
Inch Spec	MFH 050R-14-4T	●	4	50	27	33	32	47	22.225	12	—	50	19	5	8.4	2 (5) *2	2	+10°	Yes	Fig.1	0.4	8,800		
	MFH 063R-14-4T	●	4	63	40	46	45	60	22.225	19	11	50	19	5	8.4						0.6	7,400		
	063R-14-5T	●	5	63	40	46	45	60	22.225	19	11	50	19	5	8.4						0.6	7,400		
	MFH 080R-14-5T	●	5	80	57	63	62	76	31.75	26	17	63	32	8	12.7						1.3	6,400		
	080R-14-6T	●	6	80	57	63	62	76	31.75	26	17	63	32	8	12.7						1.3	6,400		
	MFH 100R-14-6T	●	6	100	77	83	82	96	31.75	26	17	63	32	8	12.7						2.4	5,600		
	100R-14-7T	●	7	100	77	83	82	96	31.75	26	17	63	32	8	12.7						2.4	5,600		
	MFH 125R-14-7T	●	7	125	102	108	107	100	38.1	55	—	63	38	10	15.9						2.9	4,800		
Metric Spec	MFH 160R-14-8T	●	8	160	137	143	142	100	50.8	72	—	63	38	11	19.1	3.9	4,200	No	Fig.2					
	MFH 050R-14-4T-M	●	4	50	27	33	32	47	22	12	—	50	21	6.3	10.4	2 (5) *2	2	+10°	Yes	Fig.1	0.4	8,800		
Metric Spec	MFH 063R-14-4T-22M	●	4	63	40	46	45	60	22	19	11	50	21	6.3	10.4						0.6	7,400		
	063R-14-5T-22M	●	5	63	40	46	45	60	22	19	11	50	21	6.3	10.4						0.6	7,400		
Metric Spec	063R-14-4T-27M	●	4	63	40	46	45	60	27	20	13	50	24	7	12.4						0.6	7,400		
	063R-14-5T-27M	●	5	63	40	46	45	60	27	20	13	50	24	7	12.4						0.6	7,400		
Metric Spec	MFH 080R-14-5T-M	●	5	80	57	63	62	76	27	20	13	63	24	7	12.4						1.4	6,400		
	080R-14-6T-M	●	6	80	57	63	62	76	27	20	13	63	24	7	12.4						1.4	6,400		
Metric Spec	MFH 100R-14-6T-M	●	6	100	77	83	82	96	32	26	17	63	28	8	14.4						2.4	5,600		
	100R-14-7T-M	●	7	100	77	83	82	96	32	26	17	63	28	8	14.4					2.4	5,600			
Metric Spec	MFH 125R-14-7T-M	●	7	125	102	108	107	100	40	55	—	63	33	9	16.4					2.8	4,800			
	MFH 160R-14-8T-M	●	8	160	137	143	142	100	40	68	66.7	63	32	9	16.4					3.7	4,200	No	Fig.3	

MFH050R-14-4T and MFH050R-14-4T-M have double screws. Read the instruction manual attached to the toolholder for handling method.

*1 Refer to APMX 2 on Page 16 *2 Dimension in () is when mounting LD Type ●: Std. Item

Caution with Max. Revolution

Set the number of revolutions per minute within the recommended cutting speed specified by the workpiece on page 19-20. Do not use the end mill or cutter at the maximum revolution or higher since the centrifugal force may cause chips and parts to scatter even under no load.

Spare Parts and Applicable Inserts

Description	Spare Parts					Applicable Inserts					
	Clamp Screw	Wrench		Anti-Seize Compound	Arbor Clamp Bolt						
MFH050R-10-...(-M)	SB-4090TRPN	DTPM	TTP	P-37	HH10×30	SOMT100420ER-GM SOMT100420ER-GH SOMT100420ER-LD SOMT100420ER-FL					
MFH063R-10-...(-22M)											
MFH063R-10-...-27M											
MFH080R-10-...											
MFH080R-10-...-M											
Recommended Torque for Insert Clamp 3.5N·m											
MFH050R-14-...(-M)	SB-50120TRP	TTP-20	P-37	HH10×30	W10×31		SOMT140520ER-GM SOMT140520ER-GH SOMT140520ER-LD SOMT140514ER-FL				
MFH063R-14-...(-22M)											
MFH063R-14-...-27M											
MFH080R-14-...											
MFH080R-14-...-M											
Recommended Torque for Insert Clamp 4.5N·m											
MFH100R-14-...						HH12×35					
MFH100R-14-...-M						HH16×40					
MFH125R-14-...						—					
MFH160R-14-...						—					

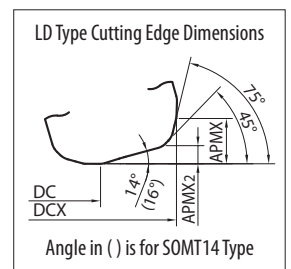

Coat Anti-Seize Compound (P-37) thinly on portion of taper and thread prior to installation.

Recommended Cutting Conditions → P19, P20

MFH Harrier | Head

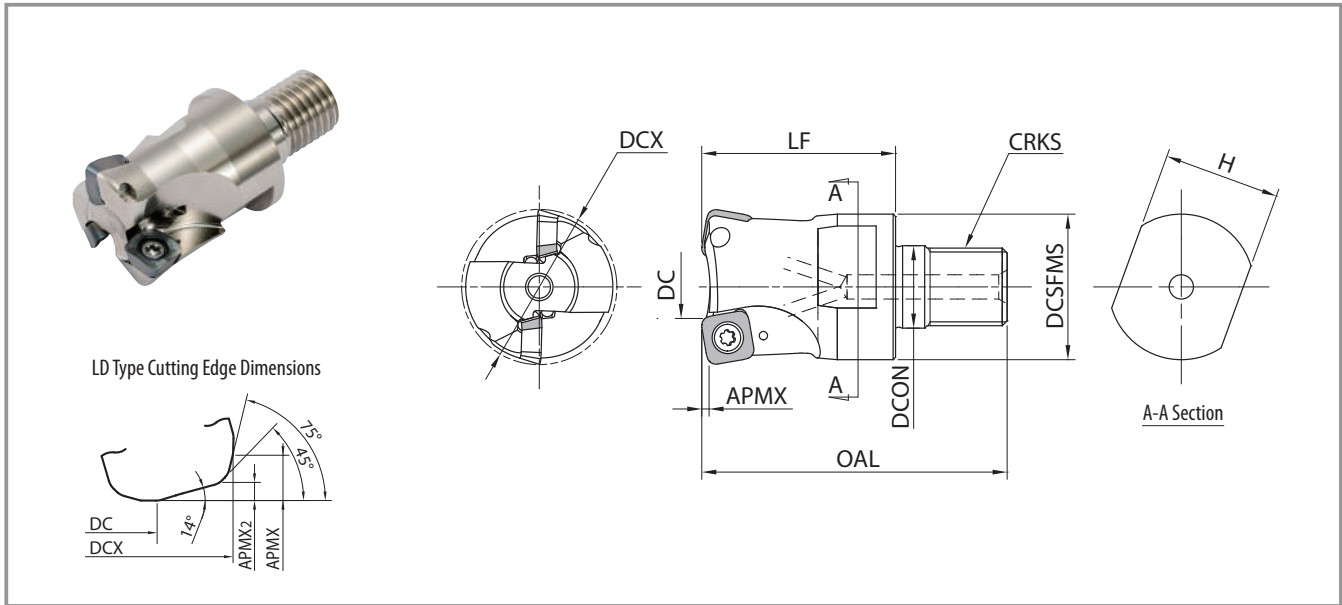

Toolholder Dimensions

Description	Stock	No. of Inserts	Dimensions (mm)											Rake Angle	Coolant Hole	Max. Revolution (min ⁻¹)	
			DCX	DC			DCSFMS	DCON	OAL	LF	CRKS	H	APMX				APMX ₂
GM-GH	LD	FL															
MFH 25-M12-10-2T	●	2	25	8	12.5	11.5	23	12.5	56	35	M12×P1.75	19	1.5 (3.5) *	1.2	+10°	Yes	17,000
MFH 28-M12-10-2T	●	2	28	11	15.5	14.5	23	12.5	56	35	M12×P1.75	19					15,500
MFH 32-M16-10-2T	●	2	32	15	19.5	18.5	30	17	62	40	M16×P2.0	24					14,000
MFH 32-M16-10-3T	●	3	32	15	19.5	18.5	30	17	62	40	M16×P2.0	24					14,000
MFH 35-M16-10-2T	●	2	35	18	22.5	21.5	30	17	62	40	M16×P2.0	24					13,000
MFH 35-M16-10-3T	●	3	35	18	22.5	21.5	30	17	62	40	M16×P2.0	24					13,000
MFH 40-M16-10-3T	●	3	40	23	27.5	26.5	30	17	62	40	M16×P2.0	24					11,500
MFH 40-M16-10-4T	●	4	40	23	27.5	26.5	30	17	62	40	M16×P2.0	24					11,500

• Caution with Max. Revolution

Set the number of revolutions per minute within the recommended cutting speed specified by the workpiece on page 19-20. Do not use the end mill or cutter at the maximum revolution or higher since the centrifugal force may cause chips and parts to scatter even under no load.

* Dimension in () is when mounting LD Type ●: Std. Item







Spare Parts and Applicable Inserts

Description	Spare Parts			Applicable Inserts
	Clamp Screw	Wrench	Anti-Seize Compound	
MFH...-10-...	 SB-4075TRP Recommended Torque for Insert Clamp 3.5N·m	 DTPM-15	 P-37	SOMT100420ER-GM SOMT100420ER-GH SOMT100420ER-LD SOMT100420ER-FL

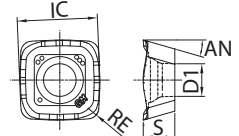
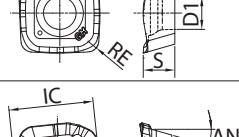
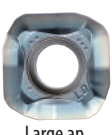
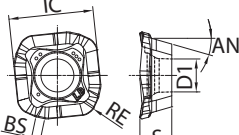
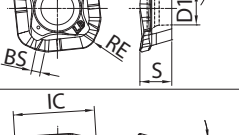
• Coat Anti-Seize Compound (P-37) thinly on portion of taper and thread prior to installation.

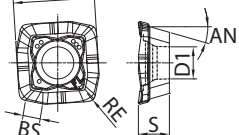
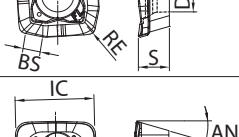
Recommended Cutting Conditions → P19, P20

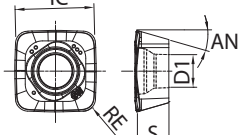
MFH Harrier | Applicable Inserts

Classification of Usage	P	Carbon Steel / Alloy Steel		☆	★									
		Die Steel		☆	★									
★ : Roughing / 1st Choice ☆ : Roughing / 2nd Choice ■ : Finishing / 1st Choice □ : Finishing / 2nd Choice	M	Austenitic Stainless Steel		★	☆									
		Martensitic Stainless Steel		☆									★	
		Precipitation Hardened Stainless Steel		★										
	K	Gray Cast Iron										★		
		Nodular Cast Iron											★	
	S	Ni-base Heat-Resistant Alloy		★										☆
		Titanium Alloy (Ti-6Al-4V)		★								☆		
H	High Hardness Steel										□			
Insert	Description	Dimensions (mm)					Angle (°)	MEGACOAT NANO			MEGACOAT HARD	CVD Coated Carbide		
		IC	S	D1	BS	RE		AN	PR1535	PR1525			PR1510	
 General Purpose	 SOMT100420ER-GM	10.30	4.58	4.6	-	2.0	16	●	●	●	-	●		
	 SOMT140520ER-GM	14.14	5.56	5.8	-	2.0	16	●	●	●	-	●		
 Large ap	 SOMT100420ER-LD	10.45	4.58	4.6	0.9	2.0	16	●	●	●	-	●		
	 SOMT140520ER-LD	14.76	5.56	5.8	1.6	2.0	16	●	●	●	-	●		
 Wiper Edge	 SOMT100420ER-FL	10.44	4.58	4.6	1.4	2.0	16	●	●	●	-	●		
	 SOMT140514ER-FL	14.57	5.56	5.8	3.1	1.4	16	●	●	●	-	●		
 Tough Edge	 SOMT100420ER-GH	10.43	4.57	4.55	-	2.0	16	●	●	●	●	-		
	 SOMT140520ER-GH	14.17	5.56	5.8	-	2.0	16	●	●	●	●	-		

● : Std. Item

MFH Harrier | Cutting Performance (GM/GH/FL)

MFH25-S25-10-2T

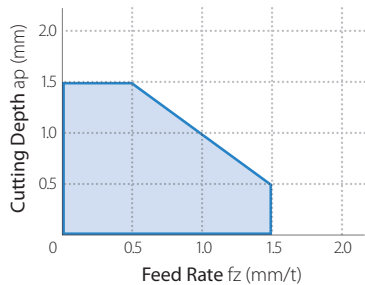

MFH32-S32-10-○T

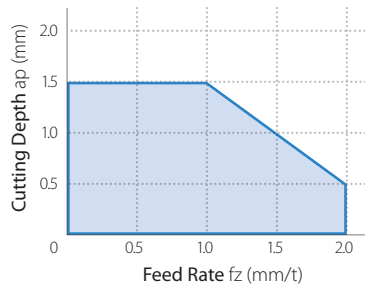

MFH40-S32-10-○T

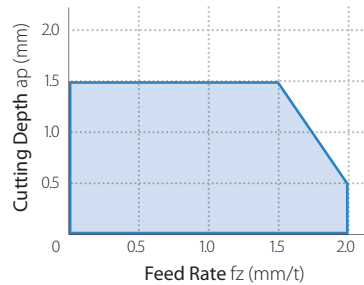

MFH050R~080R-10-○T

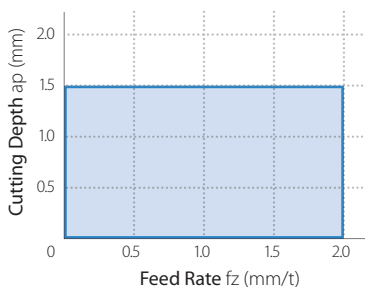

MFH.-14-○T

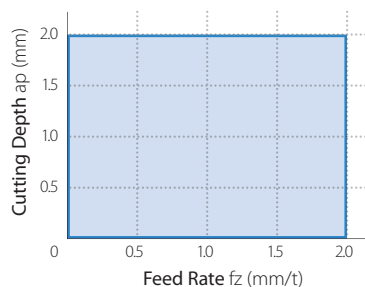

LD Chipbreaker:

- MAX D.O.C. for LD chipbreaker is 5mm (3.5mm for SOMT10 Type)
- End Mill: Please refer to the application map above
- Face Mill: Maximum feed rate (feed per tooth) fz = 2.0mm/t

MFH Harrier | Recommended Cutting Conditions ★1st Recommendation ☆2nd Recommendation

Insert	Workpiece	Holder Description and Feed Rate (fz: mm/t)					Recommended Insert Grade (Vc: m/min)					
		MFH25-	MFH32-	MFH40-	MFH...R-10	MFH...-14	MEGACOAT NANO			MEGACOAT HARD	CVD Coated Carbide	
							PR1535	PR1525	PR1510	PR015S	CA6535	
GM GH	Carbon Steel (SxxC)	0.5 - 0.8 - 1.0(ap ≤ 1.0mm) 0.2 - 0.4 - 0.5(ap ≤ 1.5mm)	0.5 - 1.0 - 1.5(ap ≤ 1.0mm) 0.3 - 0.7 - 1.0(ap ≤ 1.5mm)	0.5 - 1.2 - 1.8(ap ≤ 1.0mm) 0.4 - 1.0 - 1.5(ap ≤ 1.5mm)	0.5 - 1.5 - 2.0		☆ 120 - 180 - 250	★ 120 - 180 - 250	-	-	-	
	Alloy Steel (SCM)	0.5 - 0.8 - 1.0(ap ≤ 1.0mm) 0.2 - 0.4 - 0.5(ap ≤ 1.5mm)	0.5 - 1.0 - 1.5(ap ≤ 1.0mm) 0.3 - 0.7 - 1.0(ap ≤ 1.5mm)	0.5 - 1.2 - 1.8(ap ≤ 1.0mm) 0.4 - 1.0 - 1.5(ap ≤ 1.5mm)	0.5 - 1.5 - 2.0		☆ 100 - 160 - 220	★ 100 - 160 - 220	-	-	-	
	Die Steel (SKD)	(~40HRC)	0.5 - 0.7 - 0.8(ap ≤ 1.0mm) 0.2 - 0.3 - 0.4(ap ≤ 1.5mm)	0.5 - 0.8 - 1.2(ap ≤ 1.0mm) 0.3 - 0.6 - 0.8(ap ≤ 1.5mm)	0.5 - 1.0 - 1.6(ap ≤ 1.0mm) 0.4 - 0.8 - 1.2(ap ≤ 1.5mm)	0.5 - 1.2 - 1.8		☆ 80 - 140 - 180	☆ 80 - 140 - 180	-	GH★ 80 - 140 - 180	-
		(40~50HRC)	0.15 - 0.3 - 0.5(ap ≤ 1.0mm) 0.15 - 0.2 - 0.25(ap ≤ 1.5mm)	0.2 - 0.5 - 0.8(ap ≤ 1.0mm) 0.2 - 0.3 - 0.45(ap ≤ 1.5mm)	0.2 - 0.6 - 0.9(ap ≤ 1.0mm) 0.2 - 0.5 - 0.7(ap ≤ 1.5mm)	0.2 - 0.7 - 1.0		-	☆ 60 - 100 - 130	-	GH★ 60 - 100 - 130	-
		(50~55HRC)	0.15 - 0.25 - 0.4(ap ≤ 1.0mm)	0.15 - 0.35 - 0.6(ap ≤ 1.0mm)	0.15 - 0.4 - 0.7(ap ≤ 1.0mm)	0.2 - 0.5 - 0.8		-	☆ 50 - 70 - 100	-	GH★ 50 - 70 - 100	-
		(55~60HRC)	0.03 - 0.06 - 0.1(ap ≤ 1.0mm) (* Recommended only for GH chipbreaker)					-	-	-	GH☆ 50 - 60 - 70	-
	Austenitic Stainless Steel (SUS304)	0.5 - 0.7 - 0.8(ap ≤ 1.0mm) 0.2 - 0.3 - 0.4(ap ≤ 1.5mm)	0.5 - 0.8 - 1.2(ap ≤ 1.0mm) 0.3 - 0.6 - 0.8(ap ≤ 1.5mm)	0.5 - 1.0 - 1.6(ap ≤ 1.0mm) 0.4 - 0.8 - 1.2(ap ≤ 1.5mm)	0.5 - 1.2 - 1.8		GM☆ 100 - 160 - 200	GM☆ 100 - 160 - 200	-	-	-	
	Martensitic Stainless Steel (SUS403)	0.5 - 0.7 - 0.8(ap ≤ 1.0mm) 0.2 - 0.3 - 0.4(ap ≤ 1.5mm)	0.5 - 0.8 - 1.2(ap ≤ 1.0mm) 0.3 - 0.6 - 0.8(ap ≤ 1.5mm)	0.5 - 1.0 - 1.6(ap ≤ 1.0mm) 0.4 - 0.8 - 1.2(ap ≤ 1.5mm)	0.5 - 1.2 - 1.8		☆ 150 - 200 - 250	-	-	-	★ 180 - 240 - 300	
	Precipitation Hardened Stainless Steel (SUS630)	0.5 - 0.7 - 0.8(ap ≤ 1.0mm) 0.2 - 0.3 - 0.4(ap ≤ 1.5mm)	0.5 - 0.8 - 1.2(ap ≤ 1.0mm) 0.3 - 0.6 - 0.8(ap ≤ 1.5mm)	0.5 - 1.0 - 1.6(ap ≤ 1.0mm) 0.4 - 0.8 - 1.2(ap ≤ 1.5mm)	0.5 - 1.2 - 1.8		★ 90 - 120 - 150	-	-	-	-	
	Gray Cast Iron (FC)	0.5 - 0.8 - 1.0(ap ≤ 1.0mm) 0.2 - 0.4 - 0.5(ap ≤ 1.5mm)	0.5 - 1.0 - 1.5(ap ≤ 1.0mm) 0.3 - 0.7 - 1.0(ap ≤ 1.5mm)	0.5 - 1.2 - 1.8(ap ≤ 1.0mm) 0.4 - 1.0 - 1.5(ap ≤ 1.5mm)	0.5 - 1.5 - 2.0		-	-	★ 120 - 180 - 250	-	-	
	Nodular Cast Iron (FCD)	0.5 - 0.7 - 0.8(ap ≤ 1.0mm) 0.2 - 0.3 - 0.4(ap ≤ 1.5mm)	0.5 - 0.8 - 1.2(ap ≤ 1.0mm) 0.3 - 0.6 - 0.8(ap ≤ 1.5mm)	0.5 - 1.0 - 1.6(ap ≤ 1.0mm) 0.4 - 0.8 - 1.2(ap ≤ 1.5mm)	0.5 - 1.2 - 1.8		-	-	★ 100 - 150 - 200	-	-	
	Ni-base Heat-Resistant Alloy	0.2 - 0.4 - 0.6(ap ≤ 1.0mm) 0.15 - 0.2 - 0.3(ap ≤ 1.5mm)	0.2 - 0.5 - 0.9(ap ≤ 1.0mm) 0.2 - 0.4 - 0.6(ap ≤ 1.5mm)	0.2 - 0.6 - 1.0(ap ≤ 1.0mm) 0.2 - 0.5 - 0.8(ap ≤ 1.5mm)	0.2 - 0.8 - 1.2		☆ 20 - 30 - 50	-	-	-	★ 20 - 30 - 50	
Titanium Alloy (Ti-6Al-4V)	0.2 - 0.4 - 0.6(ap ≤ 1.0mm) 0.15 - 0.2 - 0.3(ap ≤ 1.5mm)	0.2 - 0.5 - 0.9(ap ≤ 1.0mm) 0.2 - 0.4 - 0.6(ap ≤ 1.5mm)	0.2 - 0.6 - 1.0(ap ≤ 1.0mm) 0.2 - 0.5 - 0.8(ap ≤ 1.5mm)	0.2 - 0.8 - 1.2		GM★ 40 - 60 - 80	-	GM☆ 30 - 50 - 70	-	-		
LD	Carbon Steel (SxxC)	0.5 - 0.8 - 1.0(ap ≤ 1.0mm) 0.06 - 0.1 - 0.2(ap ≤ 3.5mm)	0.5 - 1.0 - 1.5(ap ≤ 1.0mm) 0.06 - 0.15 - 0.3(ap ≤ 3.5mm)	0.5 - 1.2 - 1.8(ap ≤ 1.0mm) 0.06 - 0.2 - 0.3(ap ≤ 3.5mm)	0.5 - 1.5 - 2.0(ap ≤ 1.0mm) 0.06 - 0.2 - 0.3(ap ≤ 3.5mm)	0.5 - 1.5 - 2.0(ap ≤ 2.0mm) 0.06 - 0.2 - 0.4(ap ≤ 5.0mm)	☆ 120 - 180 - 250	★ 120 - 180 - 250	-	-	-	
	Alloy Steel (SCM)	0.5 - 0.8 - 1.0(ap ≤ 1.0mm) 0.06 - 0.1 - 0.2(ap ≤ 3.5mm)	0.5 - 1.0 - 1.5(ap ≤ 1.0mm) 0.06 - 0.15 - 0.3(ap ≤ 3.5mm)	0.5 - 1.2 - 1.8(ap ≤ 1.0mm) 0.06 - 0.2 - 0.3(ap ≤ 3.5mm)	0.5 - 1.5 - 2.0(ap ≤ 1.0mm) 0.06 - 0.2 - 0.3(ap ≤ 3.5mm)	0.5 - 1.5 - 2.0(ap ≤ 2.0mm) 0.06 - 0.2 - 0.4(ap ≤ 5.0mm)	☆ 100 - 160 - 220	★ 100 - 160 - 220	-	-	-	
	Die Steel (SKD) (~40HRC)	0.5 - 0.7 - 0.8(ap ≤ 1.0mm) 0.06 - 0.08 - 0.15(ap ≤ 3.5mm)	0.5 - 0.8 - 1.2(ap ≤ 1.0mm) 0.06 - 0.1 - 0.2(ap ≤ 3.5mm)	0.5 - 1.0 - 1.6(ap ≤ 1.0mm) 0.06 - 0.15 - 0.2(ap ≤ 3.5mm)	0.5 - 1.2 - 1.8(ap ≤ 1.0mm) 0.06 - 0.15 - 0.2(ap ≤ 3.5mm)	0.5 - 1.2 - 1.8(ap ≤ 2.0mm) 0.06 - 0.15 - 0.3(ap ≤ 5.0mm)	☆ 80 - 140 - 180	★ 80 - 140 - 180	-	-	-	
	Die Steel (SKD) (40~50HRC)	0.2 - 0.3 - 0.5(ap ≤ 1.0mm) 0.03 - 0.05 - 0.1(ap ≤ 3.5mm)	0.2 - 0.5 - 0.8(ap ≤ 1.0mm) 0.03 - 0.08 - 0.15(ap ≤ 3.5mm)	0.2 - 0.6 - 0.9(ap ≤ 1.0mm) 0.03 - 0.1 - 0.15(ap ≤ 3.5mm)	0.2 - 0.7 - 1.0(ap ≤ 1.0mm) 0.03 - 0.1 - 0.15(ap ≤ 3.5mm)	0.2 - 0.7 - 1.0(ap ≤ 2.0mm) 0.03 - 0.1 - 0.2(ap ≤ 5.0mm)	☆ 60 - 100 - 130	★ 60 - 100 - 130	-	-	-	
	Austenitic Stainless Steel (SUS304)	0.5 - 0.7 - 0.8(ap ≤ 1.0mm) 0.06 - 0.08 - 0.15(ap ≤ 3.5mm)	0.5 - 0.8 - 1.2(ap ≤ 1.0mm) 0.06 - 0.1 - 0.2(ap ≤ 3.5mm)	0.5 - 1.0 - 1.6(ap ≤ 1.0mm) 0.06 - 0.15 - 0.2(ap ≤ 3.5mm)	0.5 - 1.2 - 1.8(ap ≤ 1.0mm) 0.06 - 0.15 - 0.2(ap ≤ 3.5mm)	0.5 - 1.2 - 1.8(ap ≤ 2.0mm) 0.06 - 0.15 - 0.3(ap ≤ 5.0mm)	★ 100 - 160 - 200	☆ 100 - 160 - 200	-	-	-	
	Martensitic Stainless Steel (SUS403)	0.5 - 0.7 - 0.8(ap ≤ 1.0mm) 0.06 - 0.08 - 0.15(ap ≤ 3.5mm)	0.5 - 0.8 - 1.2(ap ≤ 1.0mm) 0.06 - 0.1 - 0.2(ap ≤ 3.5mm)	0.5 - 1.0 - 1.6(ap ≤ 1.0mm) 0.06 - 0.15 - 0.2(ap ≤ 3.5mm)	0.5 - 1.2 - 1.8(ap ≤ 1.0mm) 0.06 - 0.15 - 0.2(ap ≤ 3.5mm)	0.5 - 1.2 - 1.8(ap ≤ 2.0mm) 0.06 - 0.15 - 0.3(ap ≤ 5.0mm)	☆ 150 - 200 - 250	-	-	-	★ 180 - 240 - 300	
	Precipitation Hardened Stainless Steel (SUS630)	0.5 - 0.7 - 0.8(ap ≤ 1.0mm) 0.06 - 0.08 - 0.15(ap ≤ 3.5mm)	0.5 - 0.8 - 1.2(ap ≤ 1.0mm) 0.06 - 0.1 - 0.2(ap ≤ 3.5mm)	0.5 - 1.0 - 1.6(ap ≤ 1.0mm) 0.06 - 0.15 - 0.2(ap ≤ 3.5mm)	0.5 - 1.2 - 1.8(ap ≤ 1.0mm) 0.06 - 0.15 - 0.2(ap ≤ 3.5mm)	0.5 - 1.2 - 1.8(ap ≤ 2.0mm) 0.06 - 0.15 - 0.3(ap ≤ 5.0mm)	★ 90 - 120 - 150	-	-	-	-	
	Gray Cast Iron (FC)	0.5 - 0.8 - 1.0(ap ≤ 1.0mm) 0.06 - 0.1 - 0.2(ap ≤ 3.5mm)	0.5 - 1.0 - 1.5(ap ≤ 1.0mm) 0.06 - 0.15 - 0.3(ap ≤ 3.5mm)	0.5 - 1.2 - 1.8(ap ≤ 1.0mm) 0.06 - 0.2 - 0.3(ap ≤ 3.5mm)	0.5 - 1.5 - 2.0(ap ≤ 1.0mm) 0.06 - 0.2 - 0.3(ap ≤ 3.5mm)	0.5 - 1.5 - 2.0(ap ≤ 2.0mm) 0.06 - 0.2 - 0.4(ap ≤ 5.0mm)	-	-	★ 120 - 180 - 250	-	-	
	Nodular Cast Iron (FCD)	0.5 - 0.7 - 0.8(ap ≤ 1.0mm) 0.06 - 0.08 - 0.15(ap ≤ 3.5mm)	0.5 - 0.8 - 1.2(ap ≤ 1.0mm) 0.06 - 0.1 - 0.2(ap ≤ 3.5mm)	0.5 - 1.0 - 1.6(ap ≤ 1.0mm) 0.06 - 0.15 - 0.2(ap ≤ 3.5mm)	0.5 - 1.2 - 1.8(ap ≤ 1.0mm) 0.06 - 0.15 - 0.2(ap ≤ 3.5mm)	0.5 - 1.2 - 1.8(ap ≤ 2.0mm) 0.06 - 0.15 - 0.3(ap ≤ 5.0mm)	-	-	★ 100 - 150 - 200	-	-	
	Ni-base Heat-Resistant Alloy	0.2 - 0.4 - 0.6(ap ≤ 1.0mm) 0.03 - 0.05 - 0.1(ap ≤ 3.5mm)	0.2 - 0.5 - 0.9(ap ≤ 1.0mm) 0.03 - 0.08 - 0.15(ap ≤ 3.5mm)	0.2 - 0.6 - 1.0(ap ≤ 1.0mm) 0.03 - 0.1 - 0.15(ap ≤ 3.5mm)	0.2 - 0.8 - 1.2(ap ≤ 1.0mm) 0.03 - 0.1 - 0.15(ap ≤ 3.5mm)	0.2 - 0.8 - 1.2(ap ≤ 2.0mm) 0.03 - 0.1 - 0.2(ap ≤ 5.0mm)	☆ 20 - 30 - 50	-	-	-	★ 20 - 30 - 50	
	Titanium Alloy (Ti-6Al-4V)	0.2 - 0.4 - 0.6(ap ≤ 1.0mm) 0.03 - 0.05 - 0.1(ap ≤ 3.5mm)	0.2 - 0.5 - 0.9(ap ≤ 1.0mm) 0.03 - 0.08 - 0.15(ap ≤ 3.5mm)	0.2 - 0.6 - 1.0(ap ≤ 1.0mm) 0.03 - 0.1 - 0.15(ap ≤ 3.5mm)	0.2 - 0.8 - 1.2(ap ≤ 1.0mm) 0.03 - 0.1 - 0.15(ap ≤ 3.5mm)	0.2 - 0.8 - 1.2(ap ≤ 2.0mm) 0.03 - 0.1 - 0.2(ap ≤ 5.0mm)	★ 40 - 60 - 80	-	☆ 30 - 50 - 70	-	-	

Insert	Workpiece	Holder Description and Feed Rate (fz: mm/t)					Recommended Insert Grade (Vc: m/min)				
		MFH25-	MFH32-	MFH40-	MFH...R-10	MFH...-14	MEGACOAT NANO			MEGACOAT HARD	CVD Coated Carbide
							PR1535	PR1525	PR1510	PR0155	CA6535
FL	Carbon Steel (SxxC)	0.5 - 0.8 - 1.0(ap ≤ 1.0mm) 0.2 - 0.4 - 0.5(ap ≤ 1.5mm)	0.5 - 1.0 - 1.5(ap ≤ 1.0mm) 0.3 - 0.7 - 1.0(ap ≤ 1.5mm)	0.5 - 1.2 - 1.8(ap ≤ 1.0mm) 0.4 - 1.0 - 1.5(ap ≤ 1.5mm)	0.5 - 1.5 - 2.0		☆ 120 - 180 - 250	★ 120 - 180 - 250	-	-	-
	Alloy Steel (SCM)	0.5 - 0.8 - 1.0(ap ≤ 1.0mm) 0.2 - 0.4 - 0.5(ap ≤ 1.5mm)	0.5 - 1.0 - 1.5(ap ≤ 1.0mm) 0.3 - 0.7 - 1.0(ap ≤ 1.5mm)	0.5 - 1.2 - 1.8(ap ≤ 1.0mm) 0.4 - 1.0 - 1.5(ap ≤ 1.5mm)	0.5 - 1.5 - 2.0		☆ 100 - 160 - 220	★ 100 - 160 - 220	-	-	-
	Die Steel (SKD) (~40HRC)	0.5 - 0.7 - 0.8(ap ≤ 1.0mm) 0.2 - 0.3 - 0.4(ap ≤ 1.5mm)	0.5 - 0.8 - 1.2(ap ≤ 1.0mm) 0.3 - 0.6 - 0.8(ap ≤ 1.5mm)	0.5 - 1.0 - 1.6(ap ≤ 1.0mm) 0.4 - 0.8 - 1.2(ap ≤ 1.5mm)	0.5 - 1.2 - 1.8		☆ 80 - 140 - 180	★ 80 - 140 - 180	-	-	-
	Die Steel (SKD) (40~50HRC)	0.15 - 0.3 - 0.5(ap ≤ 1.0mm) 0.15 - 0.2 - 0.25(ap ≤ 1.5mm)	0.2 - 0.5 - 0.8(ap ≤ 1.0mm) 0.2 - 0.3 - 0.45(ap ≤ 1.5mm)	0.2 - 0.6 - 0.9(ap ≤ 1.0mm) 0.2 - 0.5 - 0.7(ap ≤ 1.5mm)	0.2 - 0.7 - 1.0		☆ 60 - 100 - 130	★ 60 - 100 - 130	-	-	-
	Austenitic Stainless Steel (SUS304)	0.5 - 0.7 - 0.8(ap ≤ 1.0mm) 0.2 - 0.3 - 0.4(ap ≤ 1.5mm)	0.5 - 0.8 - 1.2(ap ≤ 1.0mm) 0.3 - 0.6 - 0.8(ap ≤ 1.5mm)	0.5 - 1.0 - 1.6(ap ≤ 1.0mm) 0.4 - 0.8 - 1.2(ap ≤ 1.5mm)	0.5 - 1.2 - 1.8		★ 100 - 160 - 200	☆ 100 - 160 - 200	-	-	-
	Martensitic Stainless Steel (SUS403)	0.5 - 0.7 - 0.8(ap ≤ 1.0mm) 0.2 - 0.3 - 0.4(ap ≤ 1.5mm)	0.5 - 0.8 - 1.2(ap ≤ 1.0mm) 0.3 - 0.6 - 0.8(ap ≤ 1.5mm)	0.5 - 1.0 - 1.6(ap ≤ 1.0mm) 0.4 - 0.8 - 1.2(ap ≤ 1.5mm)	0.5 - 1.2 - 1.8		☆ 150 - 200 - 250	-	-	-	★ 180 - 240 - 300
	Precipitation Hardened Stainless Steel (SUS630)	0.5 - 0.7 - 0.8(ap ≤ 1.0mm) 0.2 - 0.3 - 0.4(ap ≤ 1.5mm)	0.5 - 0.8 - 1.2(ap ≤ 1.0mm) 0.3 - 0.6 - 0.8(ap ≤ 1.5mm)	0.5 - 1.0 - 1.6(ap ≤ 1.0mm) 0.4 - 0.8 - 1.2(ap ≤ 1.5mm)	0.5 - 1.2 - 1.8		★ 90 - 120 - 150	-	-	-	-
	Gray Cast Iron (FC)	0.5 - 0.8 - 1.0(ap ≤ 1.0mm) 0.2 - 0.4 - 0.5(ap ≤ 1.5mm)	0.5 - 1.0 - 1.5(ap ≤ 1.0mm) 0.3 - 0.7 - 1.0(ap ≤ 1.5mm)	0.5 - 1.2 - 1.8(ap ≤ 1.0mm) 0.4 - 1.0 - 1.5(ap ≤ 1.5mm)	0.5 - 1.5 - 2.0		-	-	★ 120 - 180 - 250	-	-
	Nodular Cast Iron (FCD)	0.5 - 0.7 - 0.8(ap ≤ 1.0mm) 0.2 - 0.3 - 0.4(ap ≤ 1.5mm)	0.5 - 0.8 - 1.2(ap ≤ 1.0mm) 0.3 - 0.6 - 0.8(ap ≤ 1.5mm)	0.5 - 1.0 - 1.6(ap ≤ 1.0mm) 0.4 - 0.8 - 1.2(ap ≤ 1.5mm)	0.5 - 1.2 - 1.8		-	-	★ 100 - 150 - 200	-	-
	Ni-base Heat-Resistant Alloy	0.2 - 0.4 - 0.6(ap ≤ 1.0mm) 0.15 - 0.2 - 0.3(ap ≤ 1.5mm)	0.2 - 0.5 - 0.9(ap ≤ 1.0mm) 0.2 - 0.4 - 0.6(ap ≤ 1.5mm)	0.2 - 0.6 - 1.0(ap ≤ 1.0mm) 0.2 - 0.5 - 0.8(ap ≤ 1.5mm)	0.2 - 0.8 - 1.2		☆ 20 - 30 - 50	-	-	-	★ 20 - 30 - 50
Titanium Alloy (Ti-6Al-4V)	0.2 - 0.4 - 0.6(ap ≤ 1.0mm) 0.15 - 0.2 - 0.3(ap ≤ 1.5mm)	0.2 - 0.5 - 0.9(ap ≤ 1.0mm) 0.2 - 0.4 - 0.6(ap ≤ 1.5mm)	0.2 - 0.6 - 1.0(ap ≤ 1.0mm) 0.2 - 0.5 - 0.8(ap ≤ 1.5mm)	0.2 - 0.8 - 1.2		★ 40 - 60 - 80	-	☆ 30 - 50 - 70	-	-	

- The figure in bold font is recommended starting conditions. Adjust the cutting speed and the feed rate within the above conditions according to the actual machining situation
- Machining with coolant is recommended for Ni-base Heat-Resistant Alloy and Titanium Alloy
- Machining with BT30 or equivalent, feed rate should be reduced to 25% of recommended cutting conditions
- Internal coolant is recommended for slotting applications

Case Studies

Construction Machine Parts S25C

Vc = 220 m/min (n = 1,750 min⁻¹)
 ap x ae = 1.5 x 30 mm
 fz = 0.7 mm/t (Vf = 4,900 mm/min)
 Dry
 MFH40-S32-10-4T (4 Inserts)
 SOMT140520ER-GM PR1525

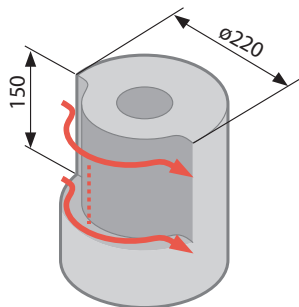

Cutting Time

PR1525

950 sec

75%
Cutting Time

Competitor J (90° Cutter)

3,800 sec

PR1525 features a higher number of passes compared to Competitor J, but the machining time was reduced by 75% because the feed rate can be increased by 7 times.
 (User Evaluation)

Clutch SUS304F

Reduced Chattering

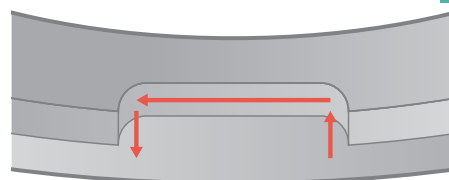

Vc = 120 m/min (n = 1,190 min⁻¹), ap x ae = 1.0 x 20 mm
 fz = 1.2 mm/t (Vf = 2,850 mm/min), Dry
 MFH32-S32-10-2T (2 Inserts), SOMT100420ER-GM PR1535

Chip Evacuation

PR1535

58 cc/min

Efficiency
x 1.6

Competitor K

36 cc/min

PR1535 shows stable machining while Competitor K generated chattering. PR1535 maintained a good cutting edge condition with stable machining.
 (User Evaluation)

BT Arbor for exchangeable head/two-face clamping

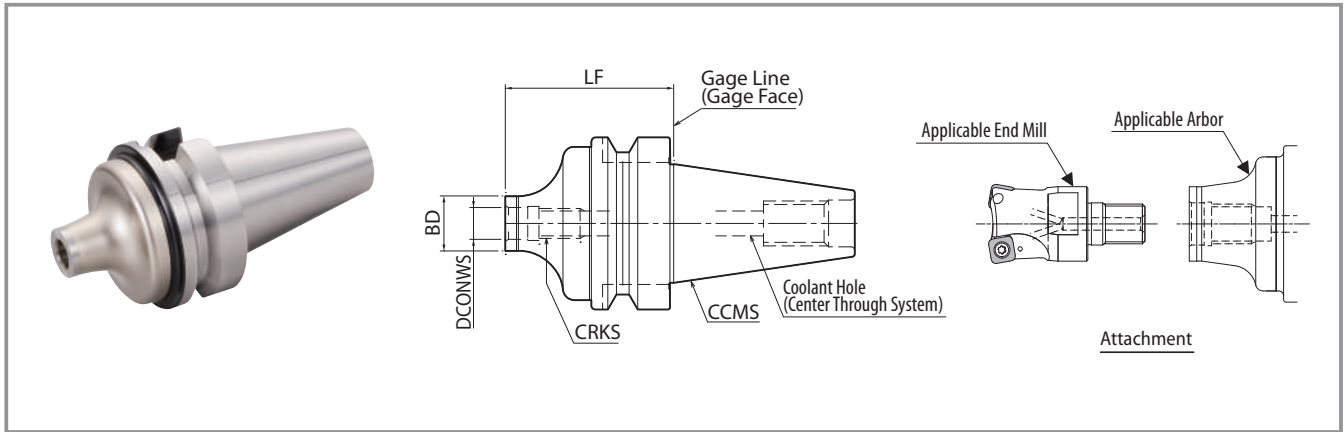

Dimensions

Description	Stock	Dimensions (mm)				Coolant Hole	Arbor (Two-face clamping)	Applicable End Mill (Head)
		LF	BD	DCONWS	CRKS			
BT30K- M08-45	●	45	14.7	8.5	M8×P1.25	Yes	BT30	MFH..-M08-..
	●	45	18.7	10.5	M10×P1.5			MFH..-M10-..
	●	45	23	12.5	M12×P1.75			MFH..-M12-..
BT40K- M08-55	●	55	14.7	8.5	M8×P1.25	Yes	BT40	MFH..-M08-..
	●	60	18.7	10.5	M10×P1.5			MFH..-M10-..
	●	55	23	12.5	M12×P1.75			MFH..-M12-..
	●	65	30	17	M16×P2.0			MFH..-M16-..

● : Std. Item

Actual End Mill Depth

Arbor Description	Applicable End Mill (Head)			Actual End Mill Depth (mm)
	Description	Cutting Dia. (mm)	Dimensions (mm)	
		DC	LF	
BT30K- M08-45	MFH16-M08-01...	16	22	28.8
	MFH16-M08-03...	16	25	31.8
	MFH17-M08-03...	17	25	33.2
	MFH18-M08-03...	18	25	34.2
M10-45	MFH20-M10-03...	20	30	36.8
	MFH22-M10-03...	22	30	39.2
M12-45	MFH25-M12-..	25	35	42.8
	MFH28-M12-..	28	35	45.5
BT40K- M08-55	MFH16-M08-01...	16	22	28.7
	MFH16-M08-03...	16	25	31.7
	MFH17-M08-03...	17	25	33.2
	MFH18-M08-03...	18	25	34.3
M10-60	MFH20-M10-03...	20	30	38.7
	MFH22-M10-03...	22	30	44.5
M12-55	MFH25-M12-..	25	35	44.6
	MFH28-M12-..	28	35	47.6
M16-65	MFH32-M16-..	32	40	51.2
	MFH35-M16-10...	35	40	60.2
	MFH40-M16-10...	40	40	64

Arbor Identification System

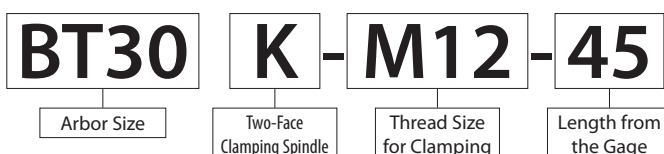

Approximate Programming Radius Adjustment

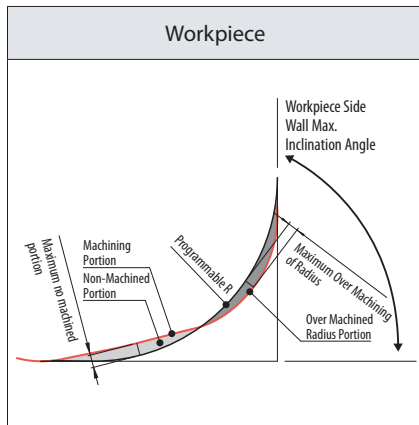

MFH Micro			MFH Mini		
Programmable R. (mm)	Maximum Over Machining of Radius (mm)	Maximum No Machined Portion (mm)	Programmable R. (mm)	Maximum Over Machining of Radius (mm)	Maximum No Machined Portion (mm)
R1.0	0	0.21	R1.6 (Recommended)	0	0.39
R1.2 (Recommended)	0	0.17	R2.0	0.09	0.35
R1.5	0.08	0.1	R2.5	0.26	0.26
R2.0	0.28	0.01	R3.0	0.46	0.17

*Cutting Edge Angle for MFH Micro/MFH Mini is 12° Workpiece Side Wall Max. Inclination Angle is 90°

MFH Harrier (GM • GH)						
Description	Insert	Cutting Edge Angle γ	Programmable R. (mm) (Recommended)	Maximum Over Machining of Radius (mm)	Maximum No Machined Portion (mm)	Workpiece Side Wall Max. Inclination Angle
MFH...-10-...	GM • GH	10°	R3.0	0	0.85	90°
	LD	14°	R3.5	0	0.69	65°
	FL	14°	R3.0	0	0.89	80°
MFH...-14-...	GM • GH	10°	R3.5	0	1.37	90°
	LD	16°	R5.0	0	1.06	65°
	FL	13°	R3.0	0	1.36	80°

Ramping Reference Data

Description	Cutting Dia. DCX (mm)	8	10	12	14	16
MFH Micro	Max. Ramping Angle RMPX	4°	3°	2°	1.5°	1.2°
	tan RMPX	0.070	0.052	0.035	0.026	0.021

Description	Cutting Dia. DCX (mm)	16	17	18	20	22	25	28	32	40	50
MFH Mini	Max. Ramping Angle RMPX	2.8°	2.5°	2.1°	1.7°	1.4°	1.2°	1°	0.8°	0.5°	0.4°
	tan RMPX	0.049	0.042	0.037	0.030	0.024	0.021	0.017	0.014	0.009	0.007

Description	Cutting Dia. DCX (mm)	25	28	32	35	40	50	63	80
MFH Harrier (MFH...-10-...)	Max. Ramping Angle RMPX	5°	4.5°	4°	3.5°	3°	2.5°	2°	1°
	tan RMPX	0.087	0.078	0.070	0.061	0.052	0.043	0.035	0.017

Description	Cutting Dia. DCX (mm)	50	63	80	100	125	160
MFH Harrier (MFH...-14-...)	Max. Ramping Angle RMPX	2°	1.8°	1°	0.5°	0.4°	0.2°
	tan RMPX	0.035	0.031	0.017	0.009	0.007	0.003

Ramping Tips

Ramping angle should be under RMPX (maximum ramping angle) in the above cutting conditions. Reduce recommended feed rate in cutting conditions above by 70%.

$$\text{Formula for Max. Cutting Length (L) at Max. Ramping Angle} \quad L = \frac{ap}{\tan \text{RMPX}}$$

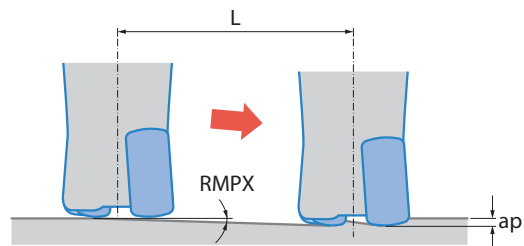

Helical Milling Tips

For Helical milling, use between Min. drilling dia. and Max. drilling dia.

Exceeding Max. Machining Dia.

Center Core Remains After Machining

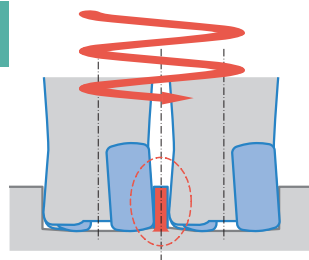

Under Min. Machining Dia.

Center Core Hits Holder Body

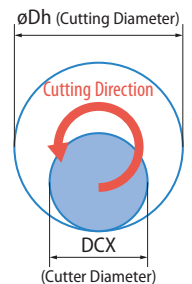
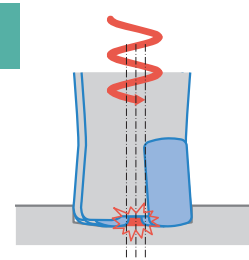

Description	Min. Cutting Dia. øDh1	Max. Cutting Dia. øDh2	Maximum Ramping Depth per Cycle
MFH Micro	2×DCX-3.5	2×DCX-2	0.5 mm
MFH Mini	2×DCX-8	2×DCX-2	1 mm
MFH Harrier (MFH...-10-...)	2×DCX-18	2×DCX-2	GM = 1.5 mm
MFH Harrier (MFH...-14-...)	2×DCX-25	2×DCX-2	GM = 2 mm

Use climb milling. (Refer to detail on right) Feed rates should be reduced to 50% of recommended cutting conditions. Use caution to eliminate incidences caused by producing long chips.

Drilling Tips

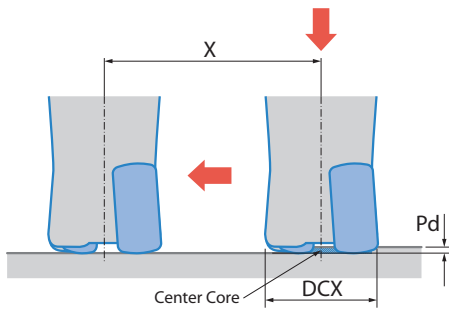

Description	Max. Drilling Depth Pd	Min. Cutting Length X for Flat Bottom Surface
MFH Micro	0.5	DCX-3.5
MFH Mini	1.0	DCX-9

Unit: mm

Description	GM • GH		LD		FL	
	Max. Drilling Depth Pd	Min. Cutting Length X for Flat Bottom Surface	Max. Drilling Depth Pd	Min. Cutting Length X for Flat Bottom Surface	Max. Drilling Depth Pd	Min. Cutting Length X for Flat Bottom Surface
MFH Harrier (MFH...-10-...)	1.5	DCX-18	1.5	DCX-14	1.5	DCX-15
MFH Harrier (MFH...-14-...)	2.0	DCX-24	2.0	DCX-18	2.0	DCX-19

It is recommended to reduce feed by 25% of recommendation until the center core is removed.

Axial feed rate recommendation per revolution is $f < 0.2\text{mm/rev}$.

Plunging

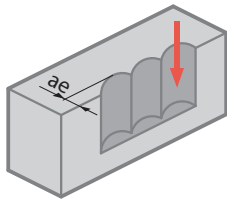

LD and FL chipbreakers are not available for plunging.

Reduce feed rate to $fz \leq 0.2\text{mm/t}$ when plunging.

Unit: mm

Description	Maximum Width of Cut (ae)
MFH Micro	1.7
MFH Mini	3.5
MFH Harrier (MFH...-10-...)	8 (GM • GH)
MFH Harrier (MFH...-14-...)	11.5 (GM • GH)

3D Machining (MFH Harrier)

GM and GH chipbreakers are available for all the applications.

Rising Wall Angle

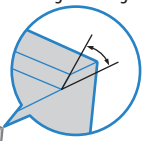
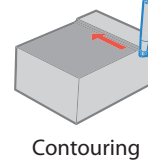
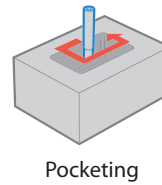
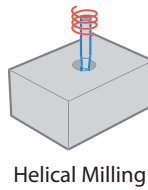
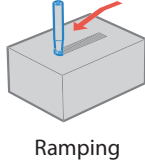
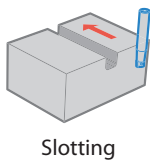
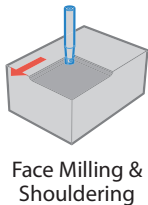

For Using MFH Harrier

Insert	Ramping	Contouring (Rising Wall Angle)	Plunging	Helical Milling	Pocketing
GM • GH	○	○ (90°)	○	○	○
LD	○	△ (65°)	×	×	×
FL	○	△ (80°)	×	×	×

*For FL and LD Type, there is a limit of rising wall angle during contouring