

MAGNIFIED VIEW OF PART "A" (2/1)

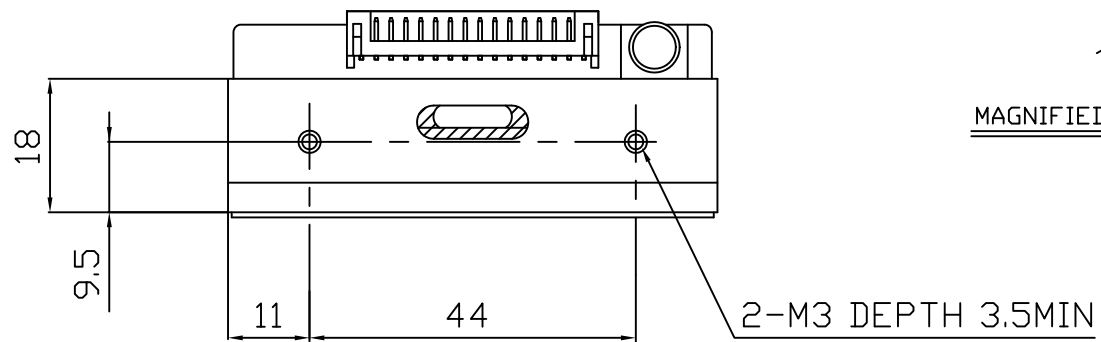

KLE-57-12WBH2-STA